

# Measurement of longitudinal single-spin asymmetries for $W^\pm$ boson production in polarized p+p collision at $\sqrt{s}=510$ GeV at RHIC

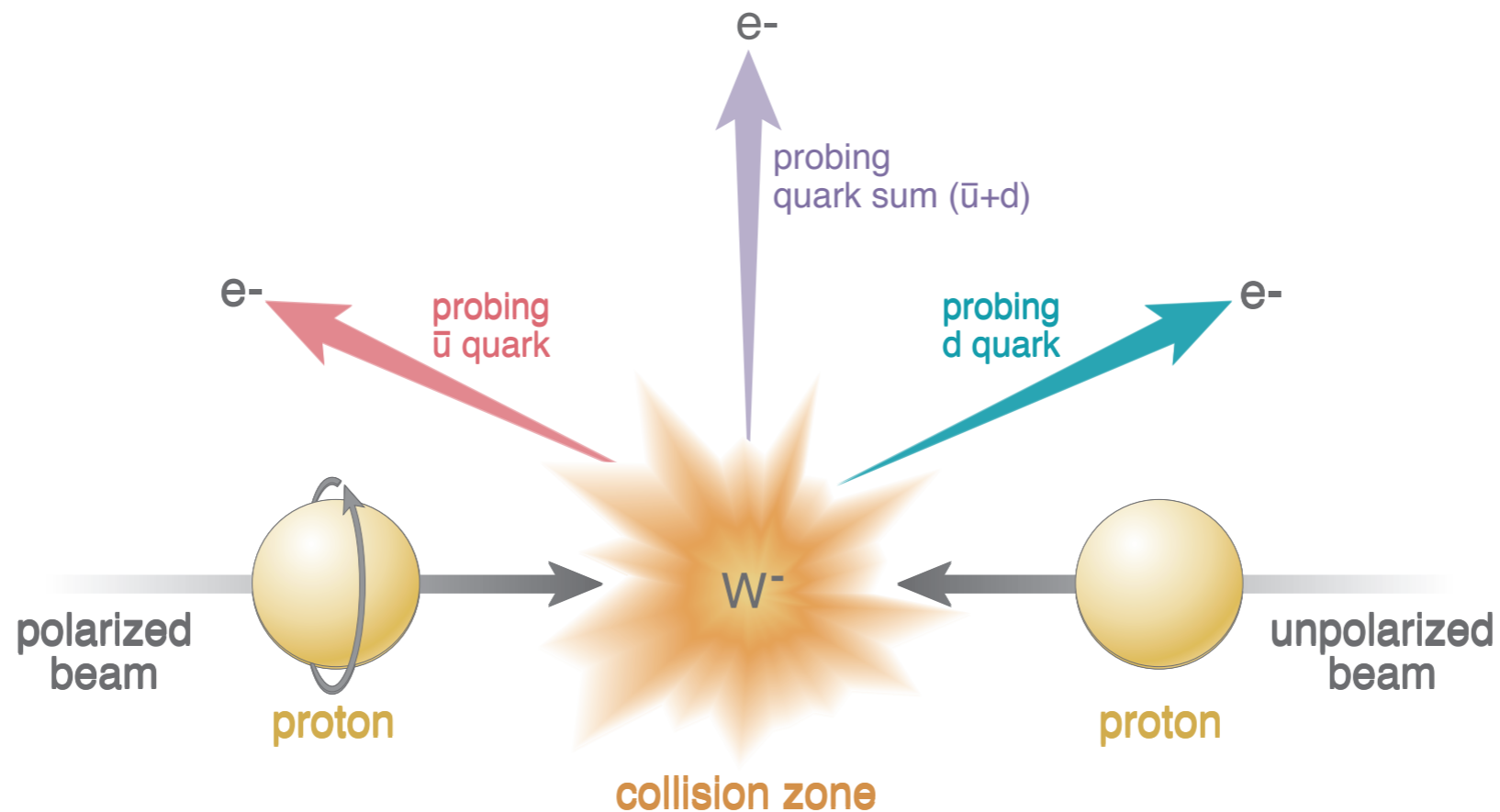

**Devika Gunarathne**  
**(for the STAR collaboration)**  
**Temple University**

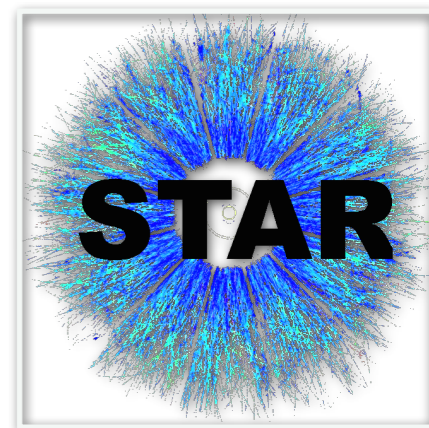

# Evolving Picture of Proton's spin

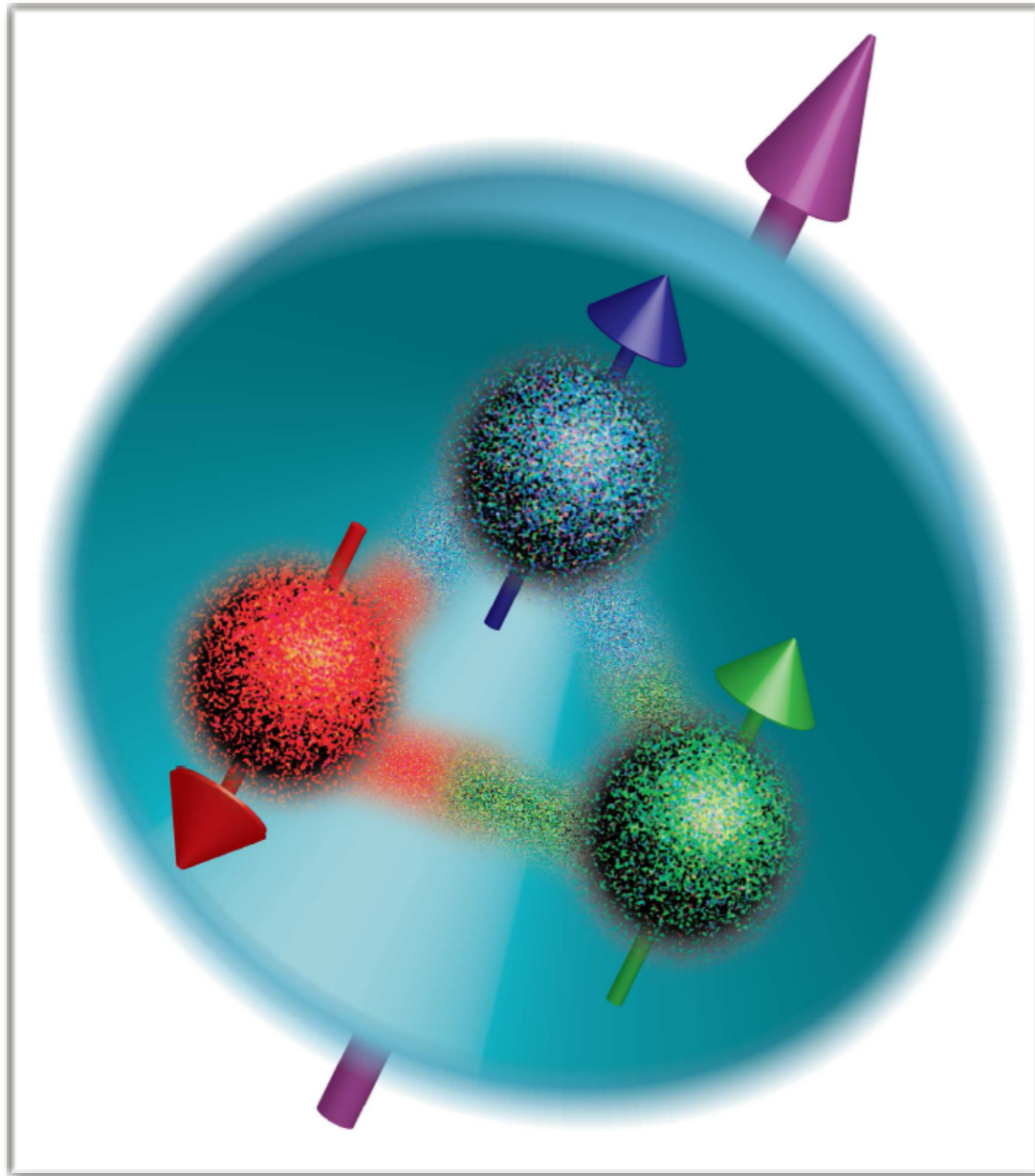

**Valance Quarks**

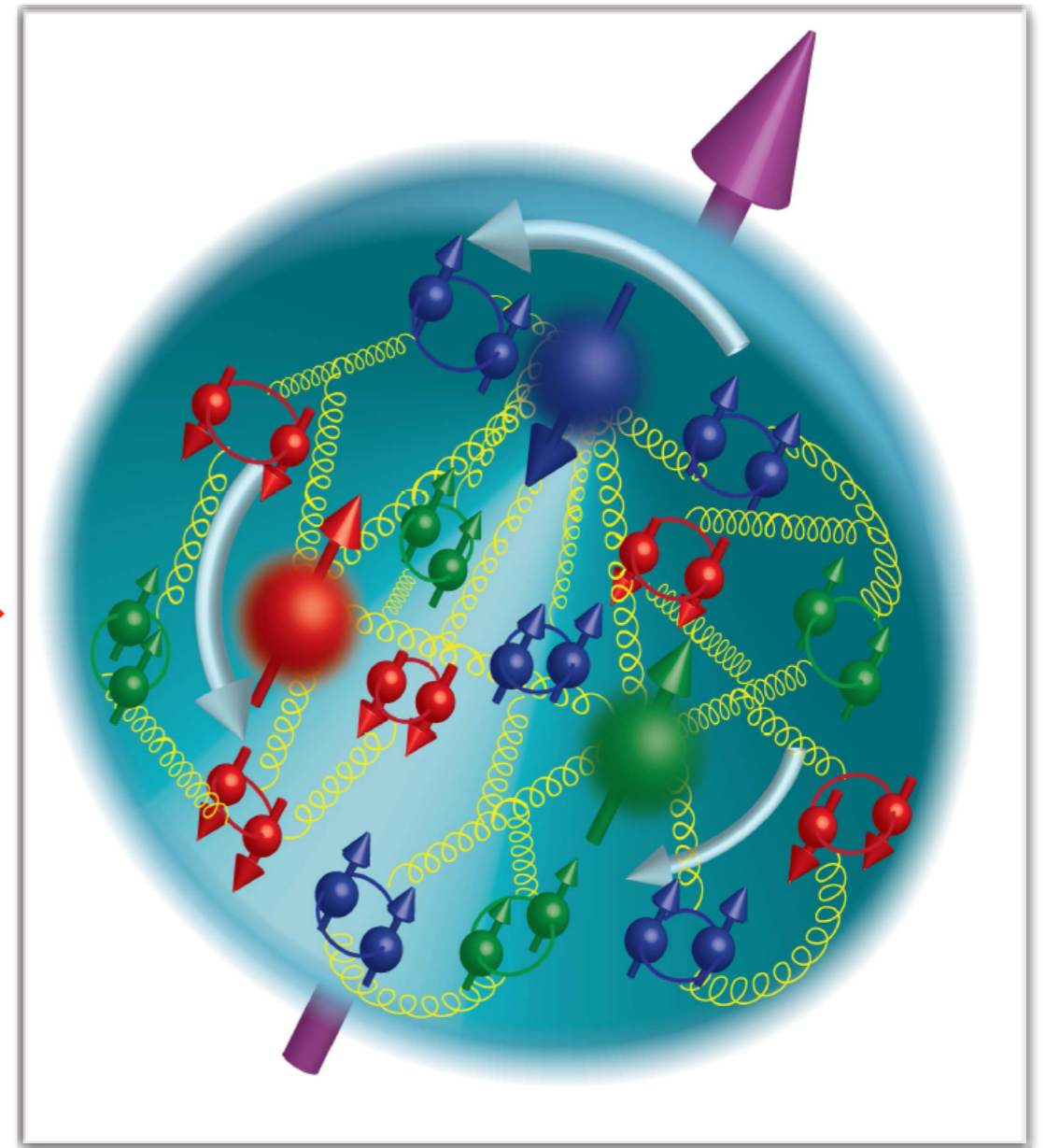
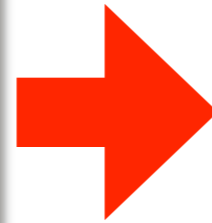

**Sea Quarks and Gluons**

# Anti Quarks Polarization

Spin sum rule for longitudinally Polarized proton :

$$\langle S_p \rangle = \frac{1}{2} = \frac{1}{2} \Delta\Sigma + \Delta G + L$$

Jaffe and Monahan, 1990

Helicity PDF

$$\Delta f(x, Q^2) \equiv f^+(x, Q^2) - f^-(x, Q^2)$$

DSSV Global Analysis

$$\Delta\Sigma = \int (\Delta u + \Delta d + \Delta s + \Delta\bar{u} + \Delta\bar{d} + \Delta\bar{s}) dx$$

~30%  
polarized  
inclusive  
DIS

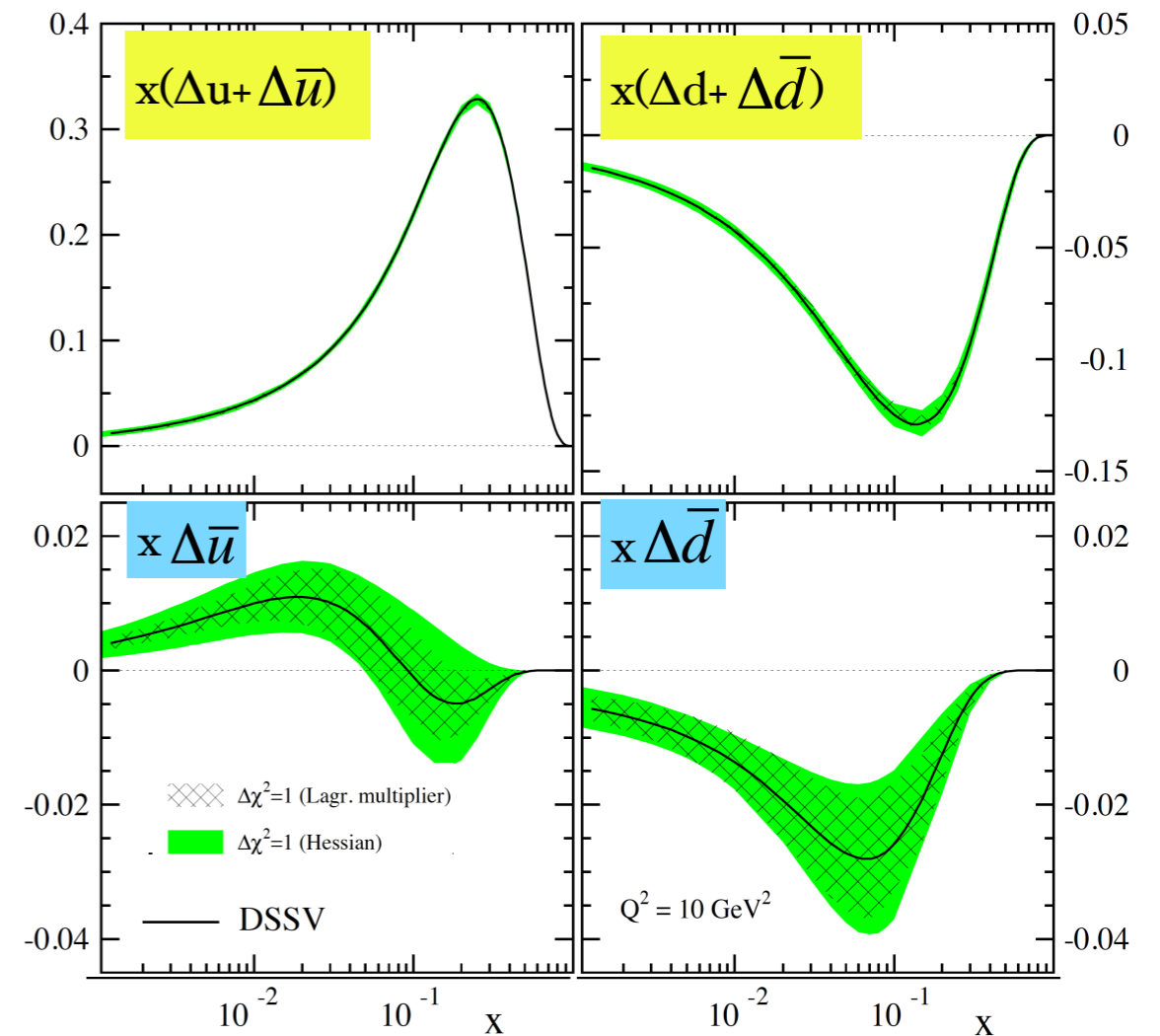
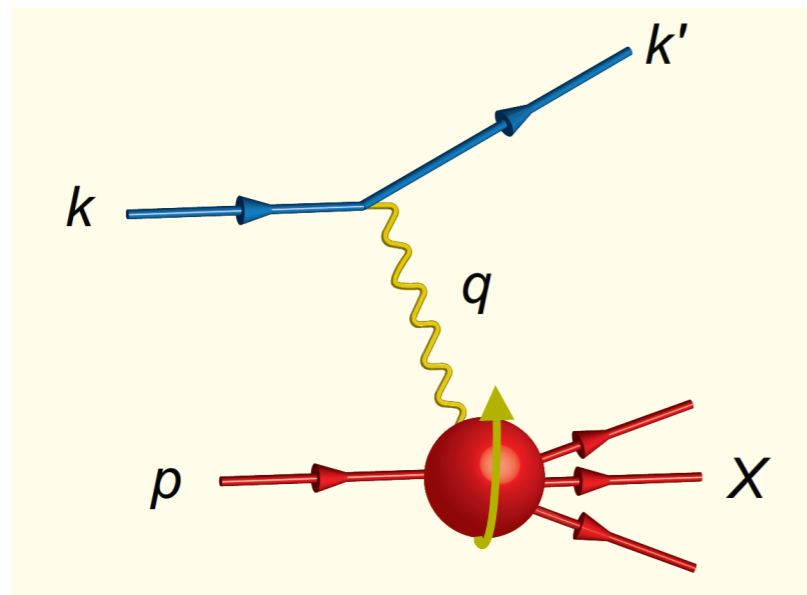

PRD 80, 034030 (2009)

# W-Boson Production

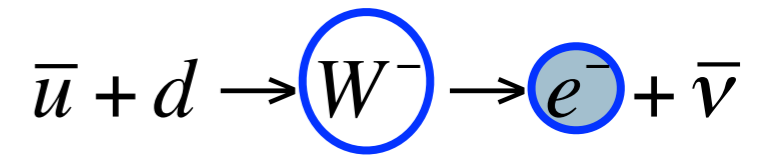
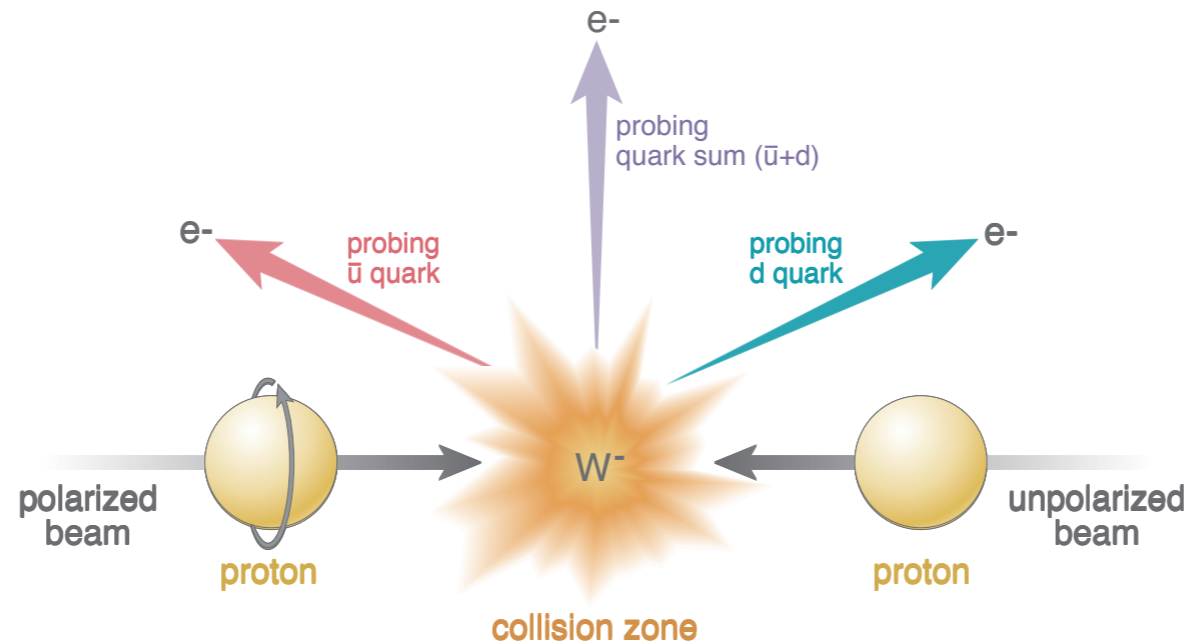
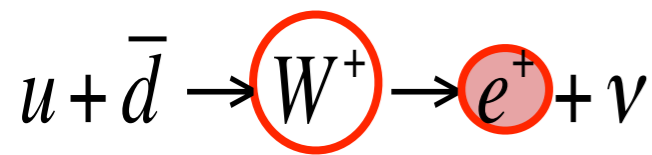

- ❖ **Maximal Violation of Parity** leads to perfect **spin separation**.
- ❖ **Direct coupling** to the **quark and antiquark of interest**.
- ❖ **Higher resolution scale ( $Q^2$ )** set by the **W mass**.
- ❖ **Easy detection** via the **leptonic decay channels**.

**Parity violating longitudinal  
single spin asymmetry**

$$A_L = \frac{\sigma^+ - \sigma^-}{\sigma^+ + \sigma^-}$$

# W A<sub>L</sub> : Theoretical Aspects

W A<sub>L</sub>, highly sensitive to individual polarizations at forward and backward decay lepton pseudo-rapidity ( $\eta_e$ )

$$\eta = -\ln\left(\tan\left(\frac{\theta}{2}\right)\right)$$

$$\langle x_{1,2} \rangle \sim \frac{M_W}{\sqrt{s}} e^{\pm\eta_e/2}$$

$$\eta \lll 0 \rightarrow x_1 \ll x_2, \theta \rightarrow \pi$$

$$\eta \ggg 0 \rightarrow x_1 \gg x_2, \theta \rightarrow 0$$

$$A_L^{W^-} \propto \frac{-\Delta d(x_1)\bar{u}(x_2) + \Delta\bar{u}(x_1)d(x_2)}{d(x_1)\bar{u}(x_2) + \bar{u}(x_1)d(x_2)}$$

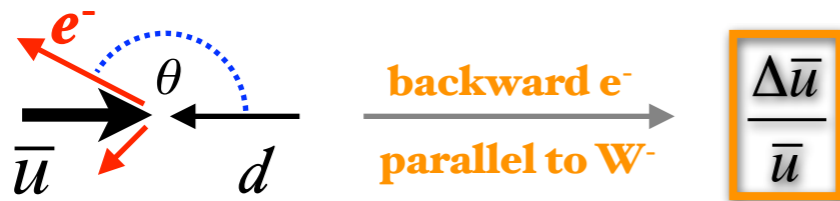

$$A_L^{W^+} \propto \frac{-\Delta u(x_1)\bar{d}(x_2) + \Delta\bar{d}(x_1)u(x_2)}{u(x_1)\bar{d}(x_2) + \bar{d}(x_1)u(x_2)}$$

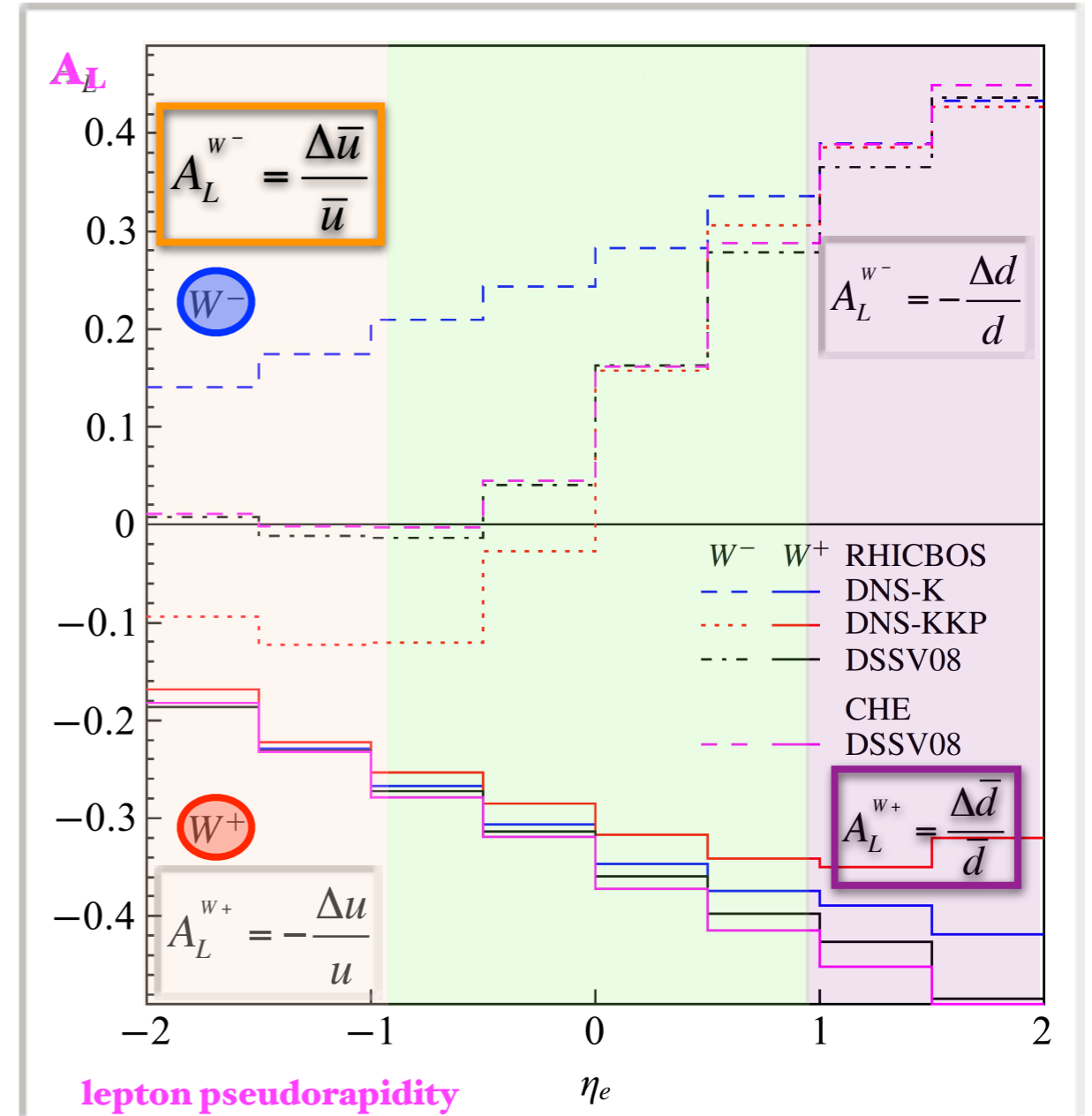

# STAR Detector Overview

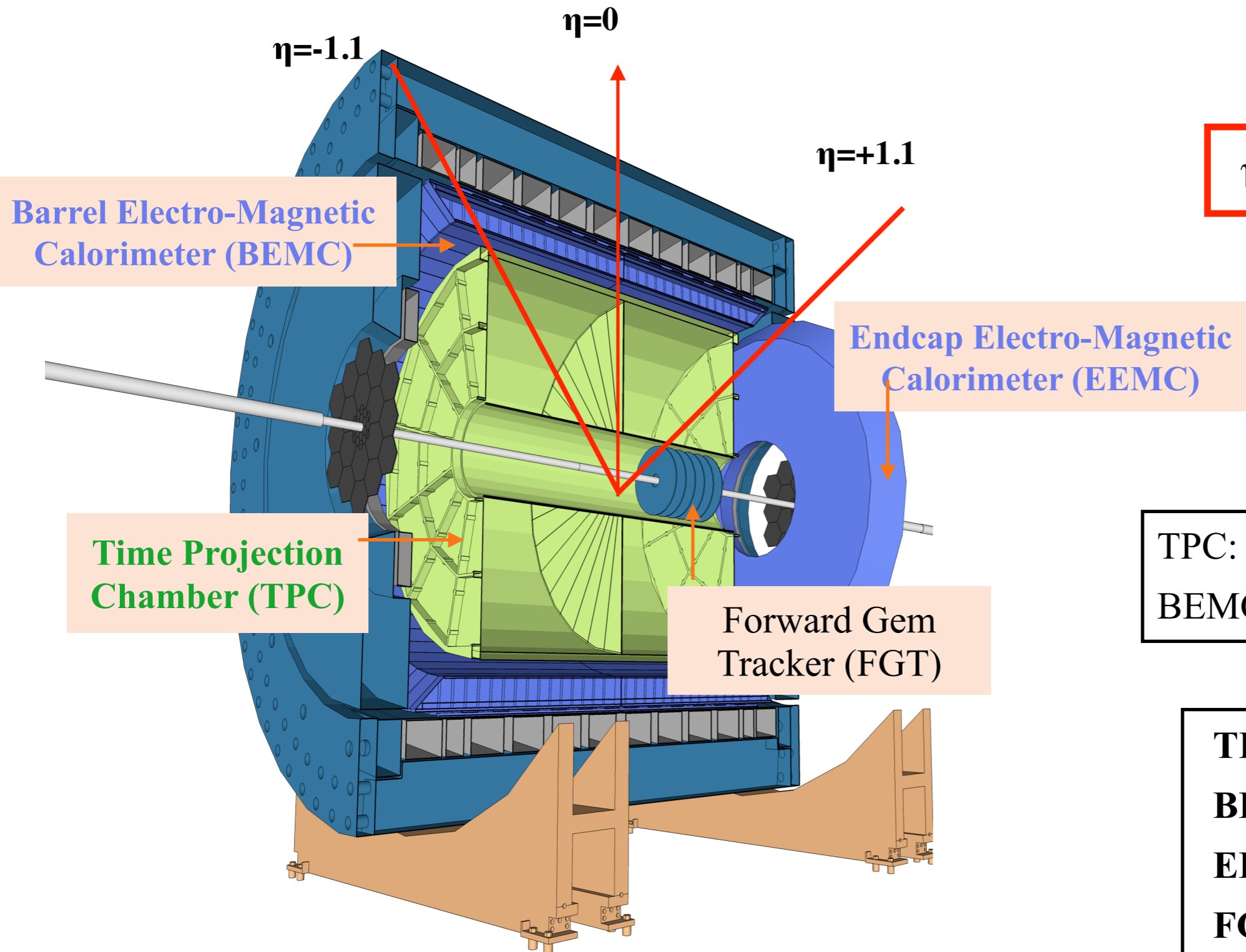

$$\eta = -\ln(\tan(\theta/2))$$

TPC: Charge particle tracking  
BEMC, EEMC: EM calorimetry

TPC :  $-1.3 < \eta < +1.3$   
BEMC :  $-1.0 < \eta < +1.0$   
EEMC :  $+1.1 < \eta < +2.0$   
FGT :  $+1.1 < \eta < +2.0$

# Mid-rapidity ( $|\eta_{el}| < 1$ ) W Selection

❖ Match  $P_T > 10$  GeV TPC tracks to BEMC cluster

❖ Isolate from QCD di-jet type event

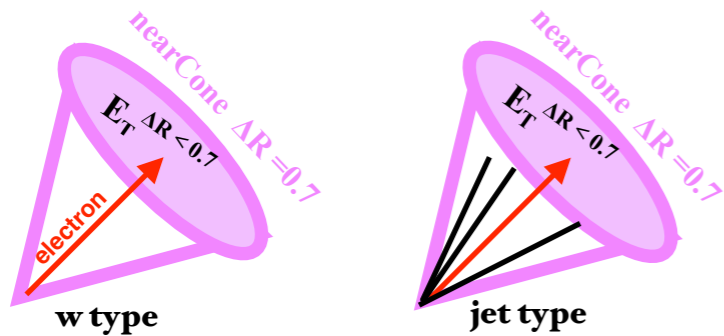

❖ Use Larger imbalance of transverse momentum

$$\vec{p}_T^{balance} = \vec{p}_T^e + \sum_{\Delta R > 0.7} \vec{p}_T^{jets}$$

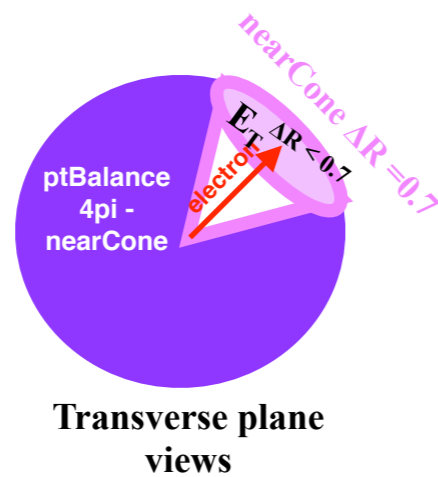

❖  $e^+$  and  $e^-$  Charge sign Separation

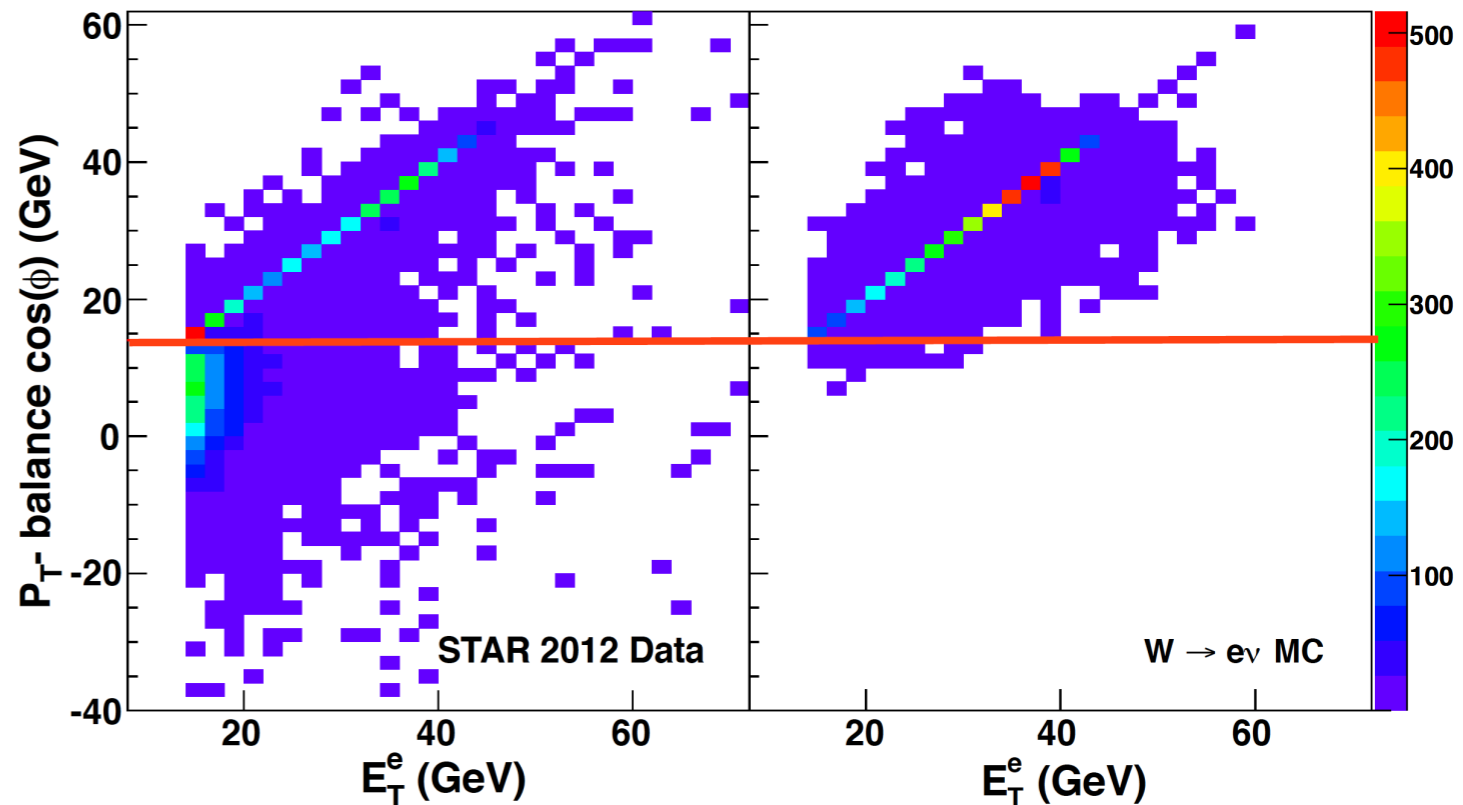
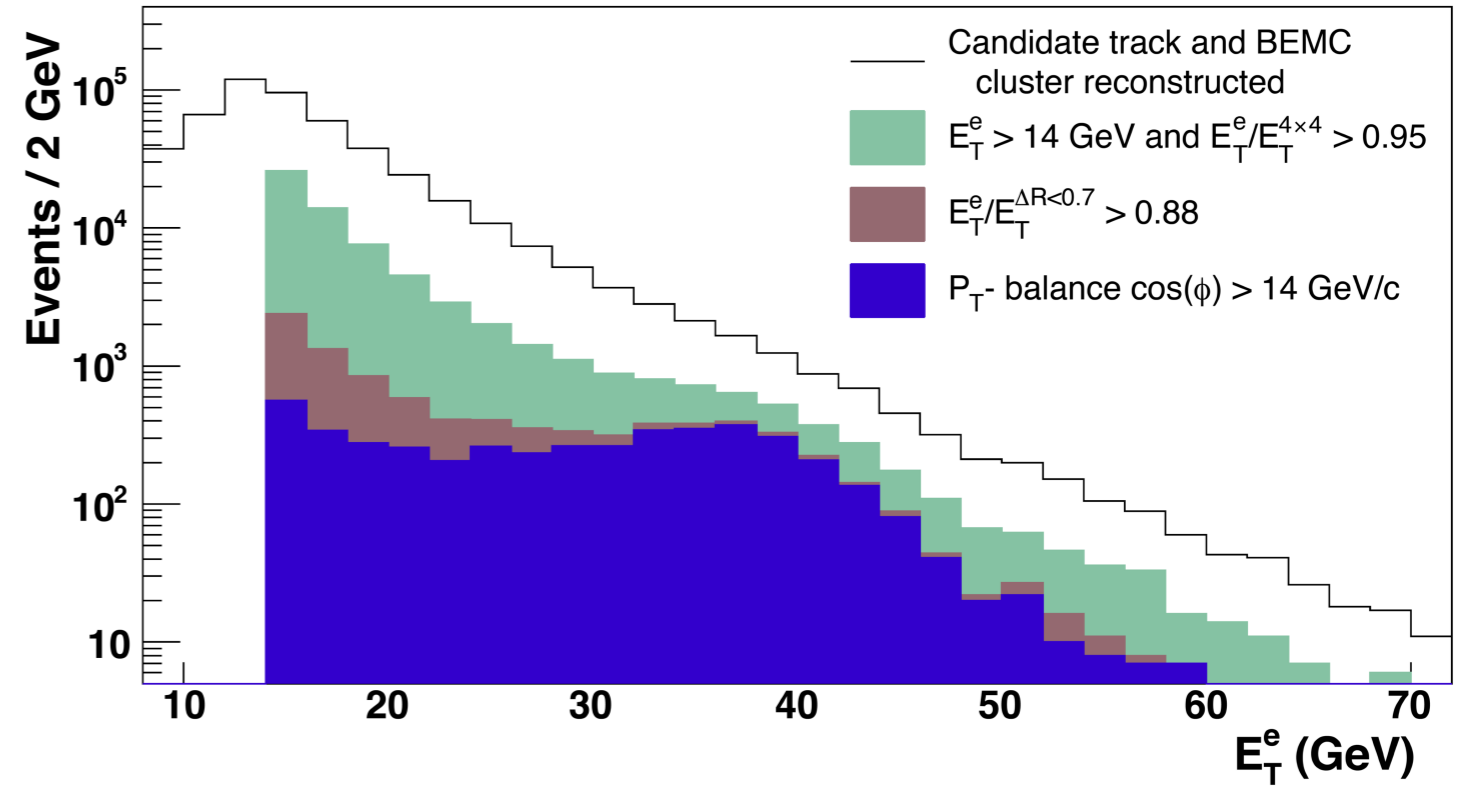

# Mid-rapidity Background Estimation

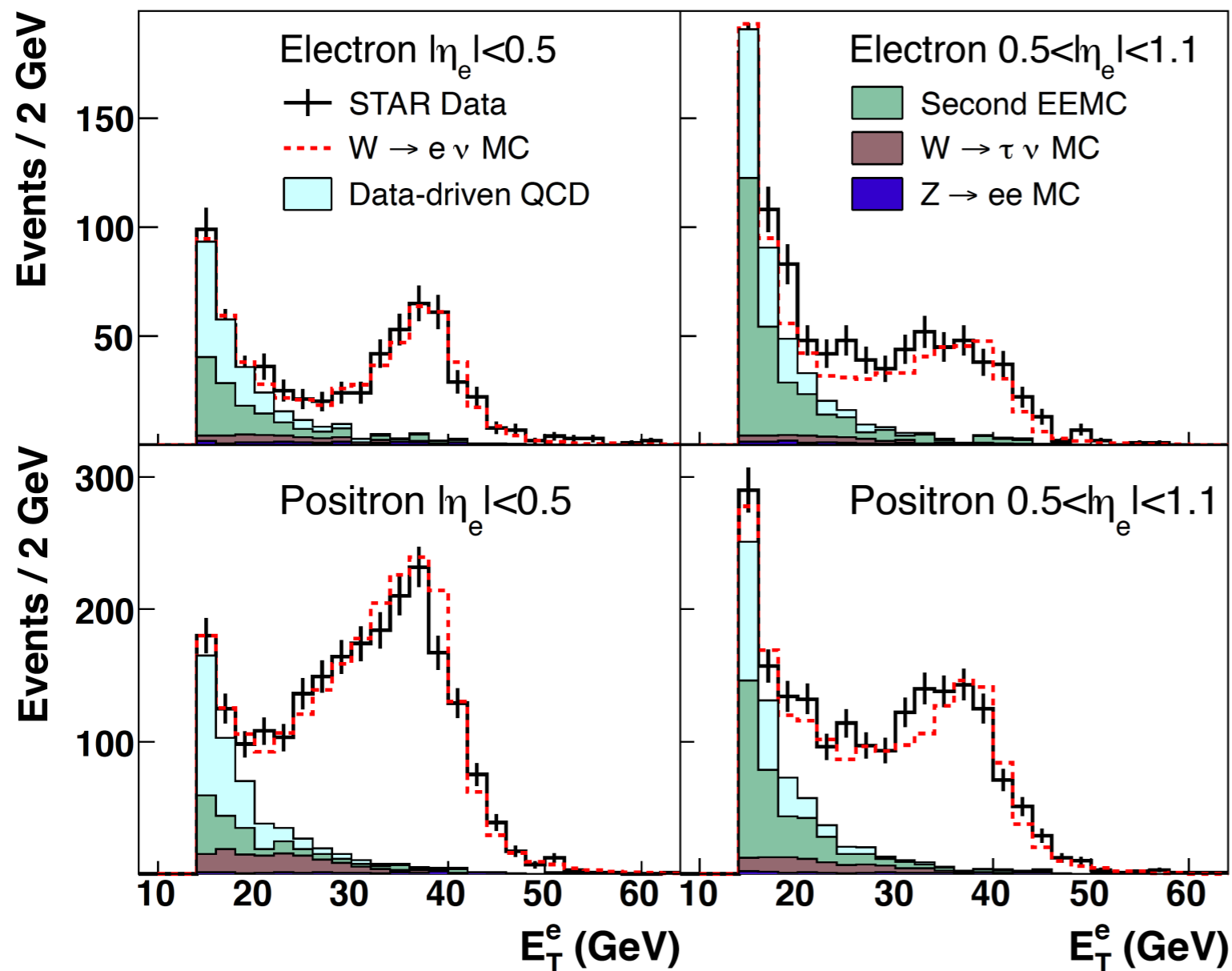

PRL 113,72301 (2014)

## ❖ Electroweak BG

\*  $W \rightarrow \tau \nu$

MC Embedded in  
Zero-bias events

\*  $Z \rightarrow e^+ e^-$

## ❖ Data driven QCD

## ❖ Second Endcap

Forward rapidity ( $1 < \eta_e < 1.4$ )  $W$  selection use similar technique as mid rapidity and Background Estimation improve using additional Endcap Shower Maximum Detector (ESMD)



# STAR 2012+2011 $W A_L(\eta_e)$

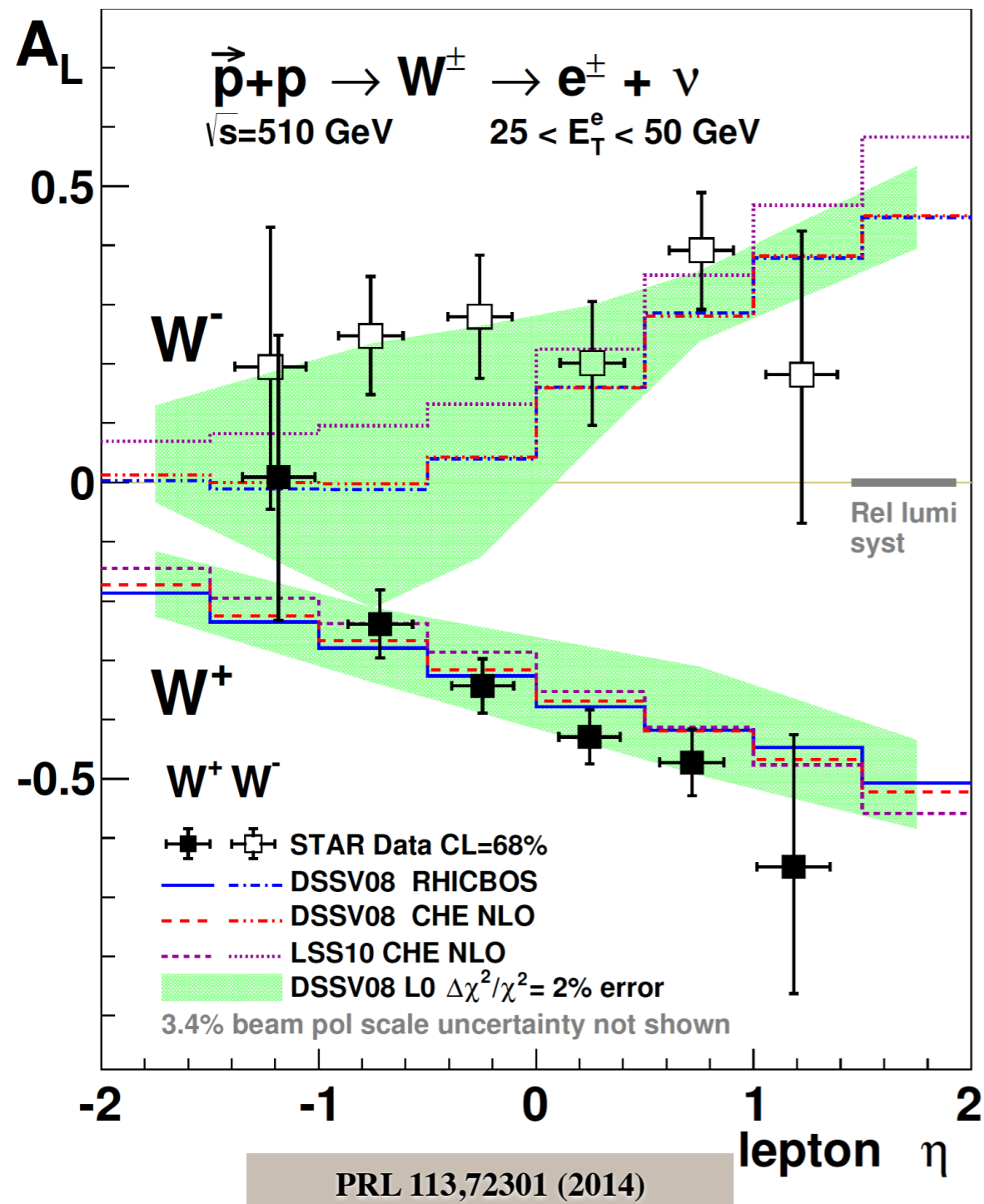

- ❖ **Profile Likelihood** method used to extract **Asymmetries** from combination of **2012** and **2011** data.
- ❖  $A_L(W^-)$  is **larger** than the DSSV Predictions.
  - ❖ The enhancement at  $\eta_e < 0$ , in particular is sensitive to the  $\Delta\bar{u}$ , polarized **antiquark distribution**.
- ❖  $A_L(W^+)$  is **consistent** with **theoretical predictions** using the DSSV polarized PDFs.
- ❖ The **Systematic uncertainties** for  $A_L$  are **well under control** for  $|\eta_e| < 1.4$ .

# Impact on Recent Global Analysis

- ❖ Preliminary Global analysis (DSSV++) from DSSV group and recent **NNPDF** includes preliminary STAR 2012 W A<sub>L</sub> data.
- ❖ **Shift** in central value for  $\Delta\bar{u}$  (negative  $\rightarrow$  positive) and  $\Delta\bar{d}$  due to A<sub>L</sub> W from STAR .
- ❖ STAR 2012 W results provide significant constraints on anti u and anti d quark polarization.

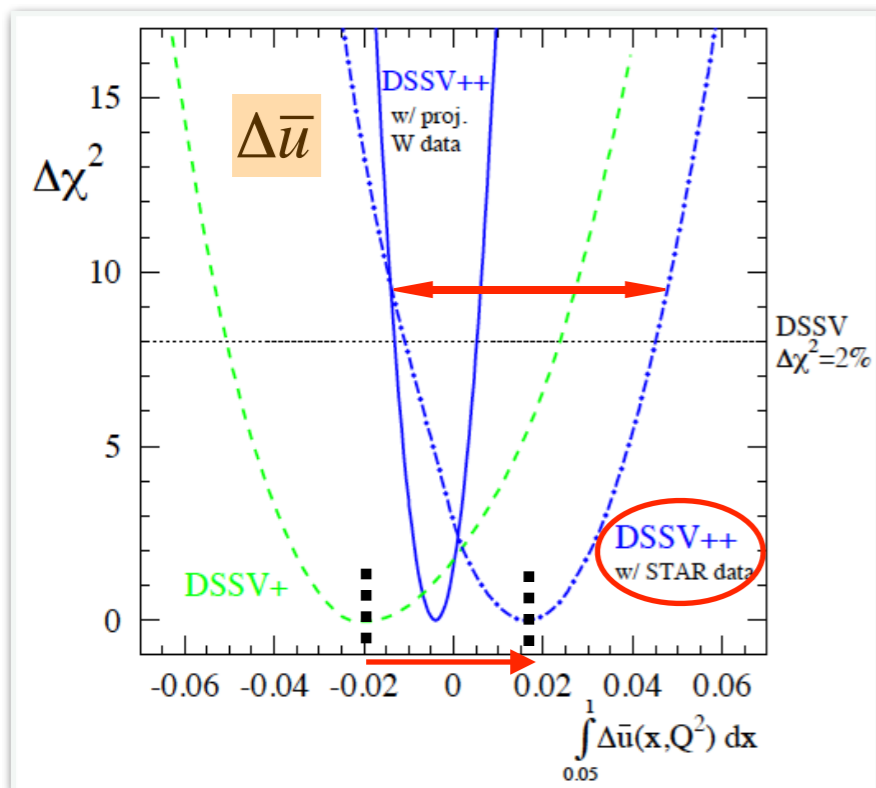

arXiv: 1304.0079

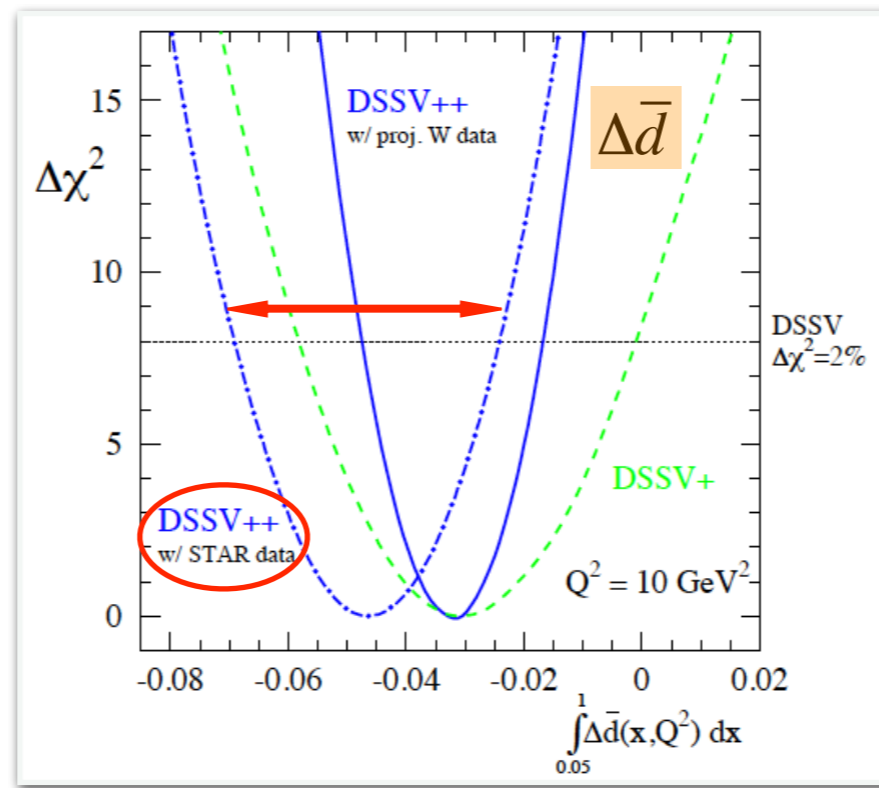

arXiv: 1304.0079

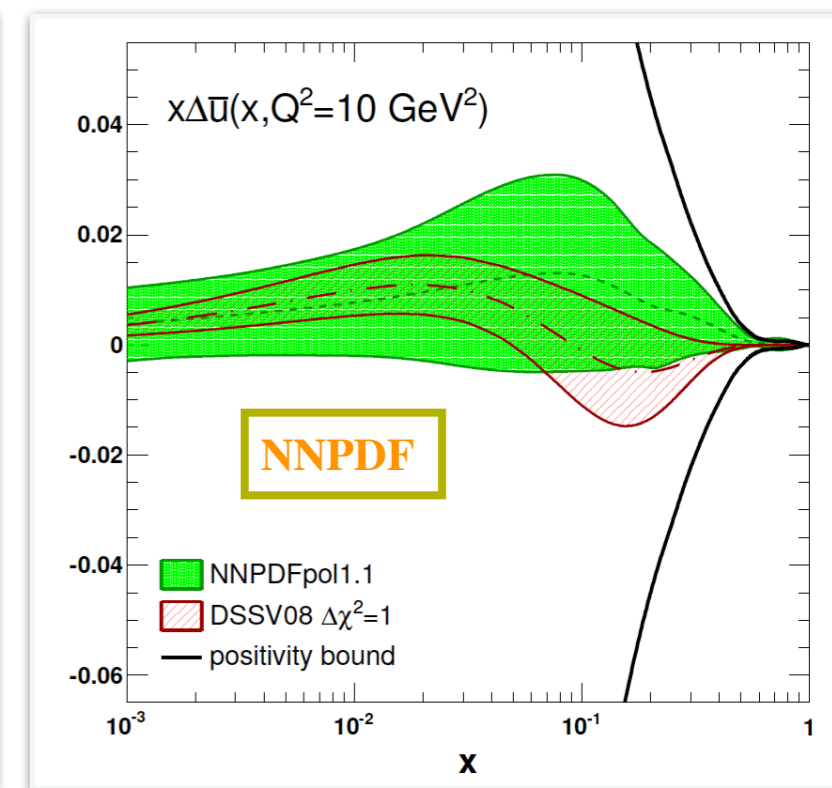

arXiv: 1403.0440

# STAR 2013 W Analysis Status

## 2013 Data Sample

### Barrel EMC triggered Integrated Luminosity

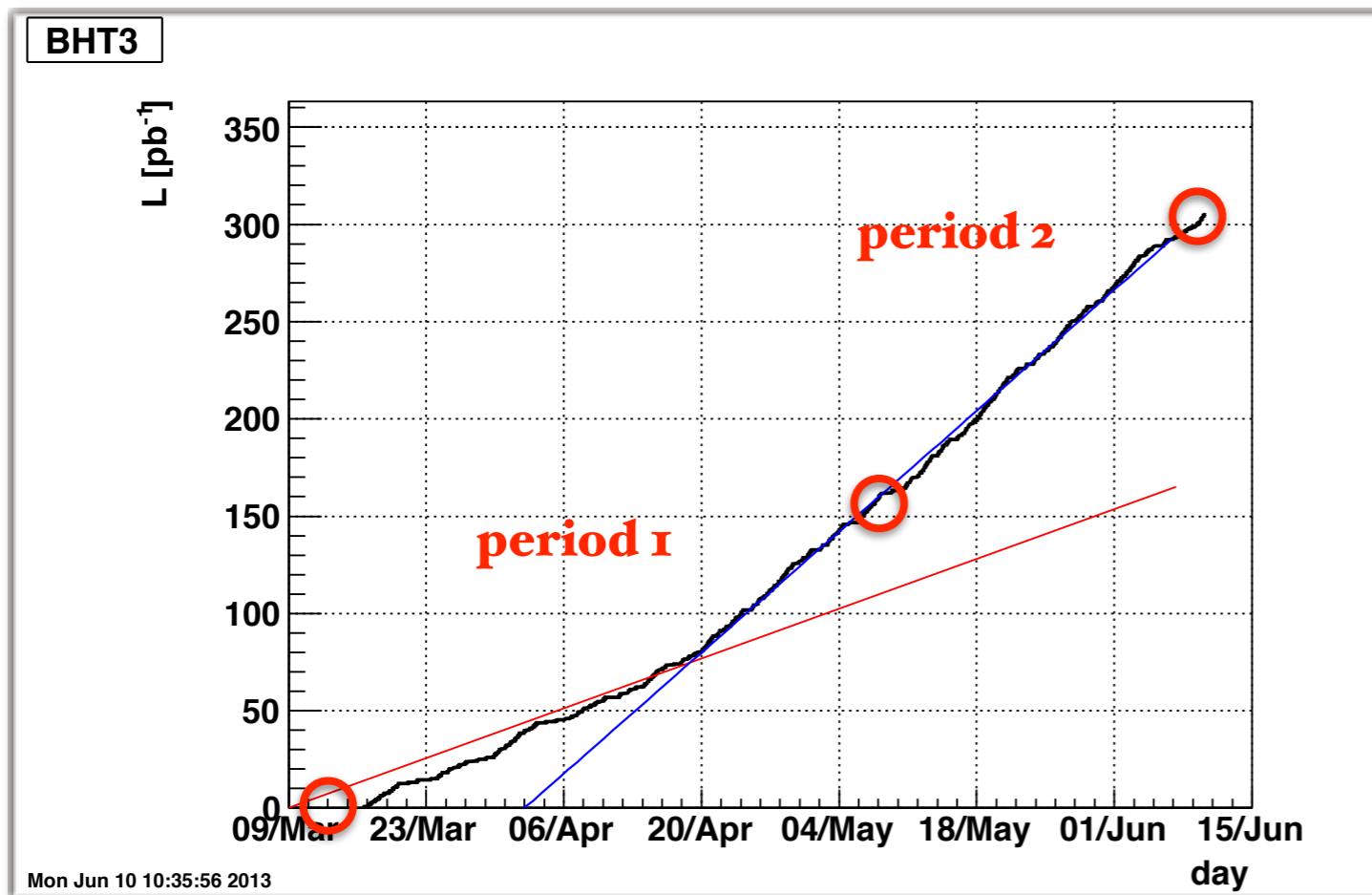

	$L$ ( $\text{pb}^{-1}$ )	$P$	$P^2L$ ( $\text{pb}^{-1}$ )
Run 9	12	0.38	1.7
Run 11	9.4	0.49	2.3
Run 12	72	0.56	24
Run 13	$\sim 300$	0.54	$\sim 87$

# Mid-rapidity Analysis Status :

## W Selection

### $e^+, e^-$ Isolation

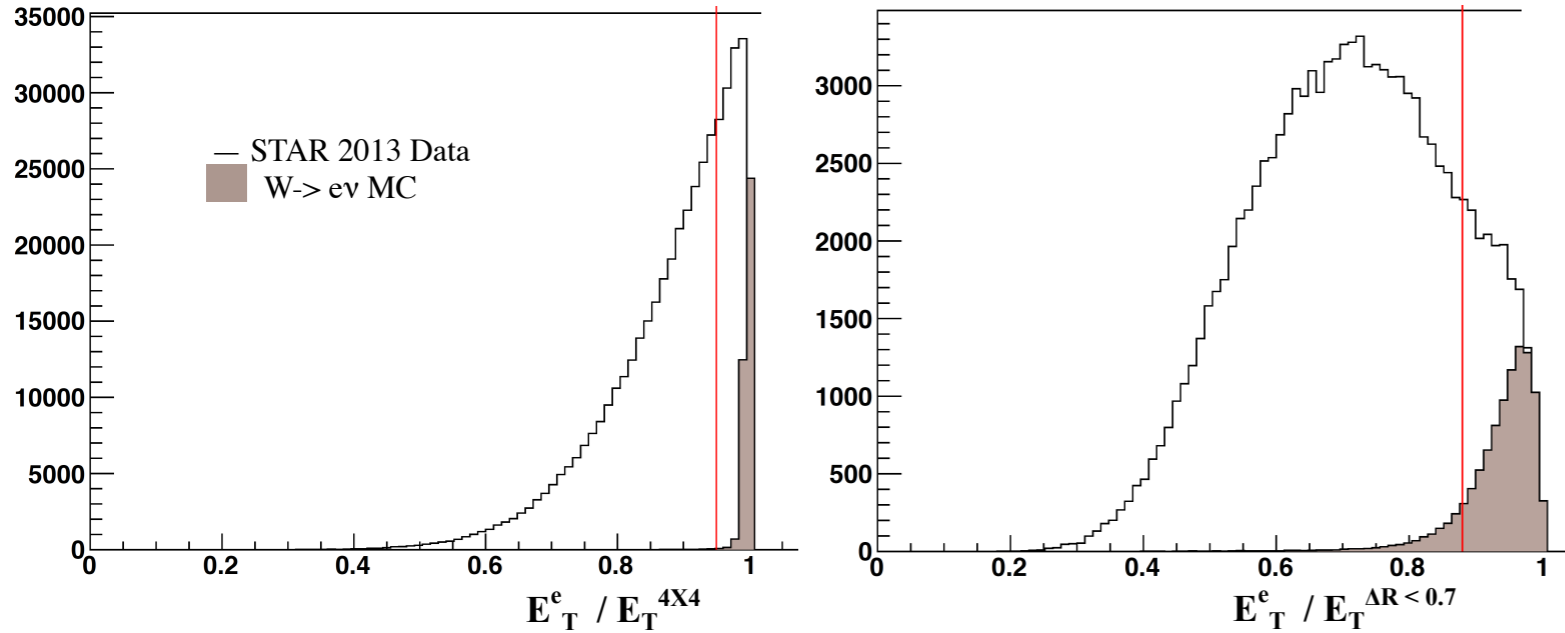

### $E_T$ distribution compare to Selection Cuts

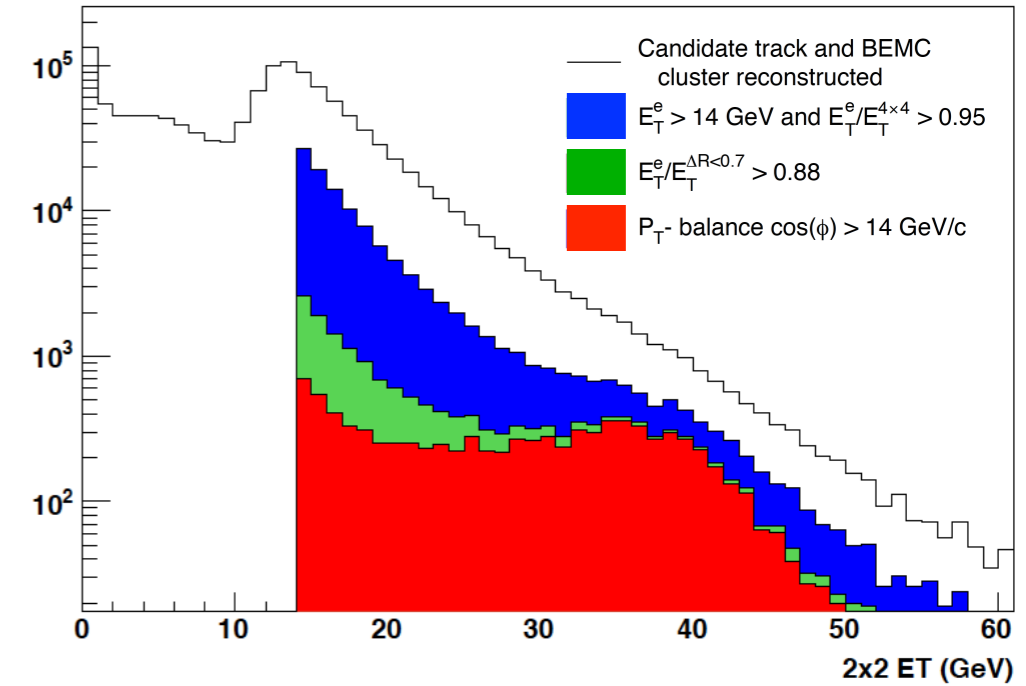

### Sign- $P_T$ balance

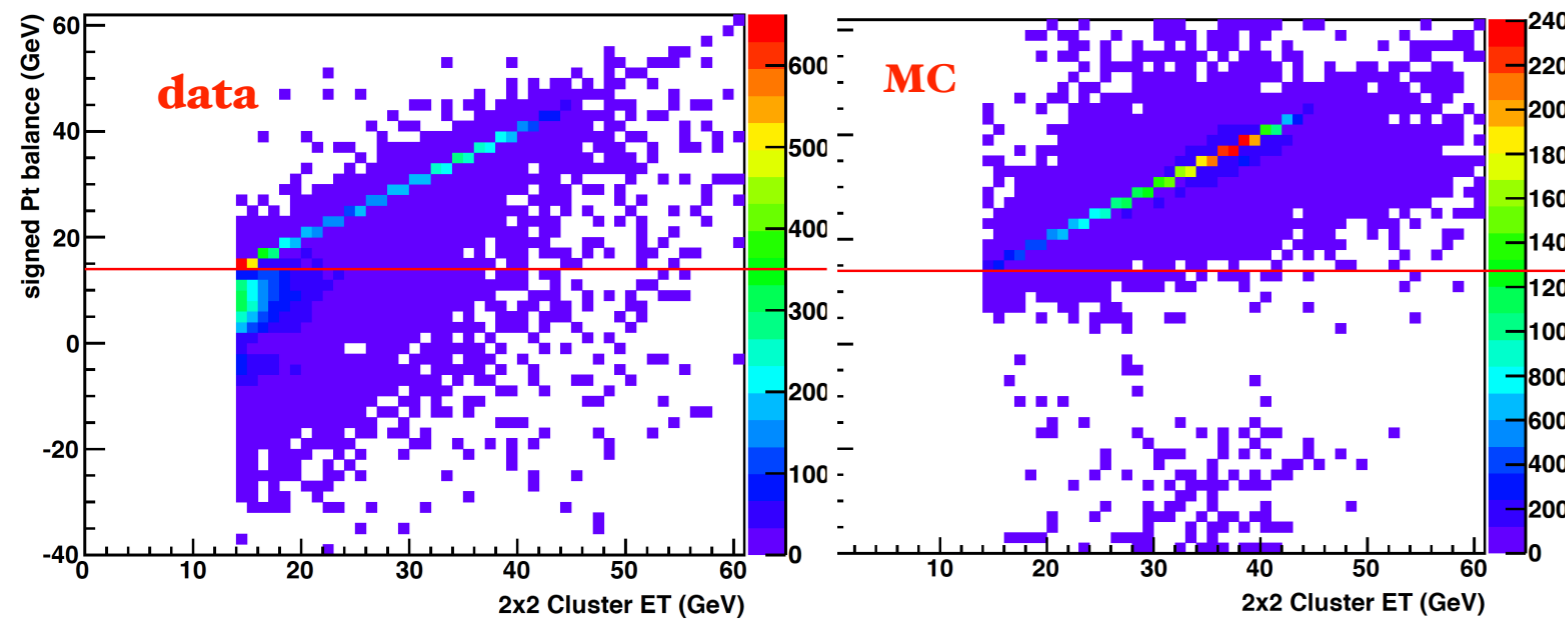

### Charge-sign Separation

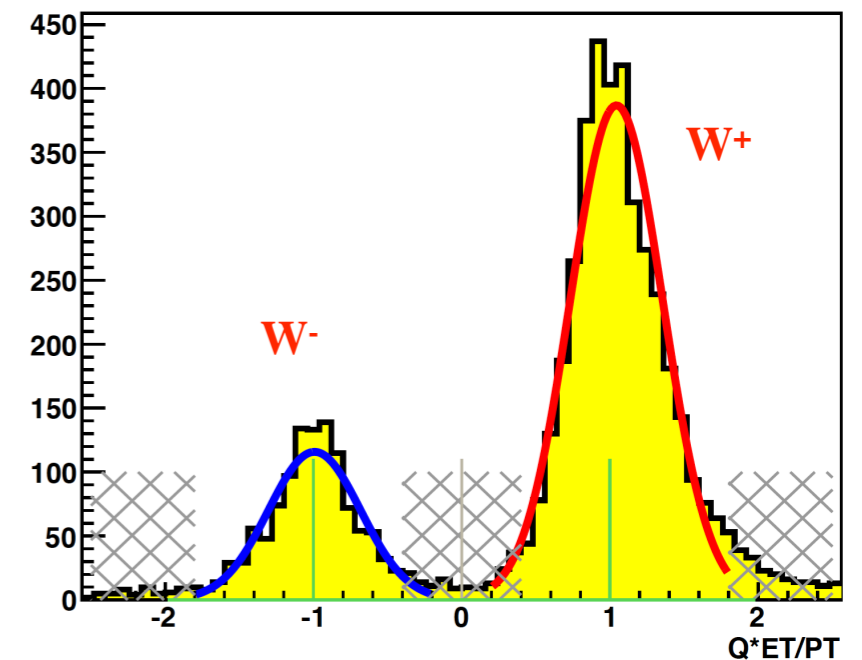

# Forward-rapidity Analysis Status :

## ● FGT (Forward Gem Tracker)

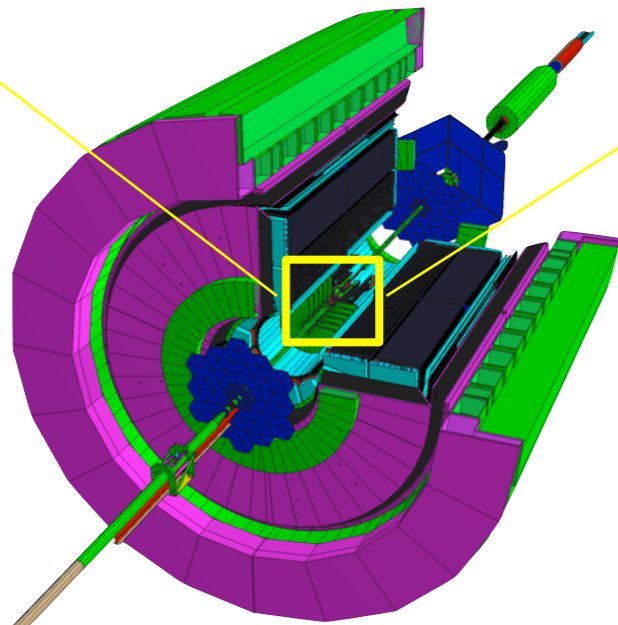
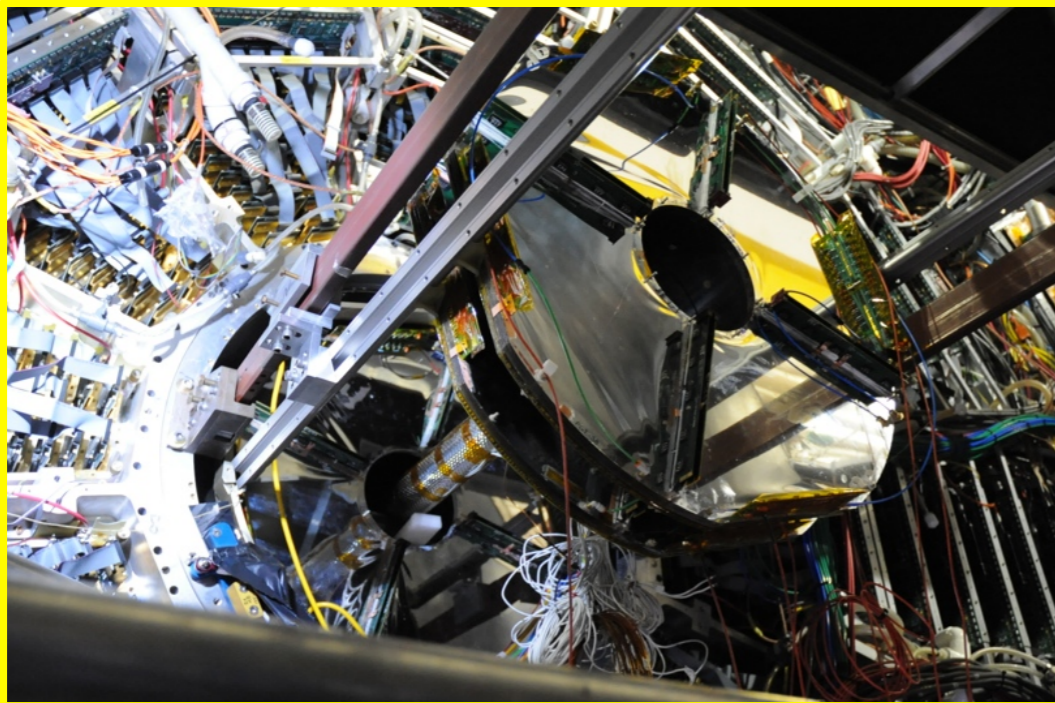

## ● W Charge-sign Separation using FGT

FGT(2 $\geq$ hits)+Vertex+EEMC+Prompt

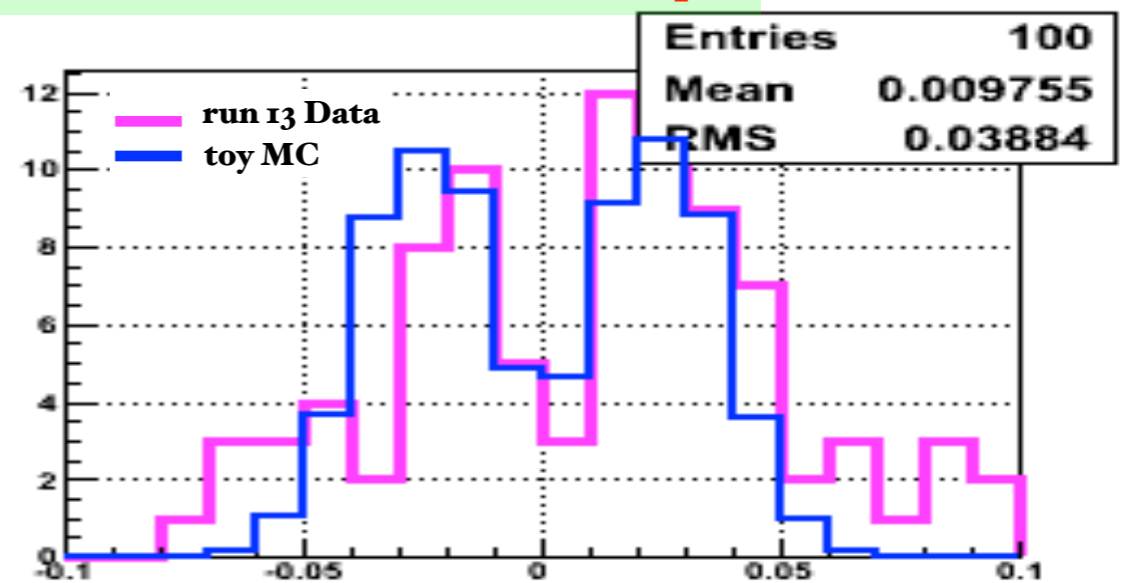

FGT res=0.02cm , VTX-XY res=0.02cm, VTX-Z res=1cm, TPC prompt res=0.1cm, EEMC res=0.3cm

~2.5 sigma separation with FGT+VTX+EEMC+PROMPT (~1/3 events)

# STAR 2013 W A<sub>L</sub> Projections

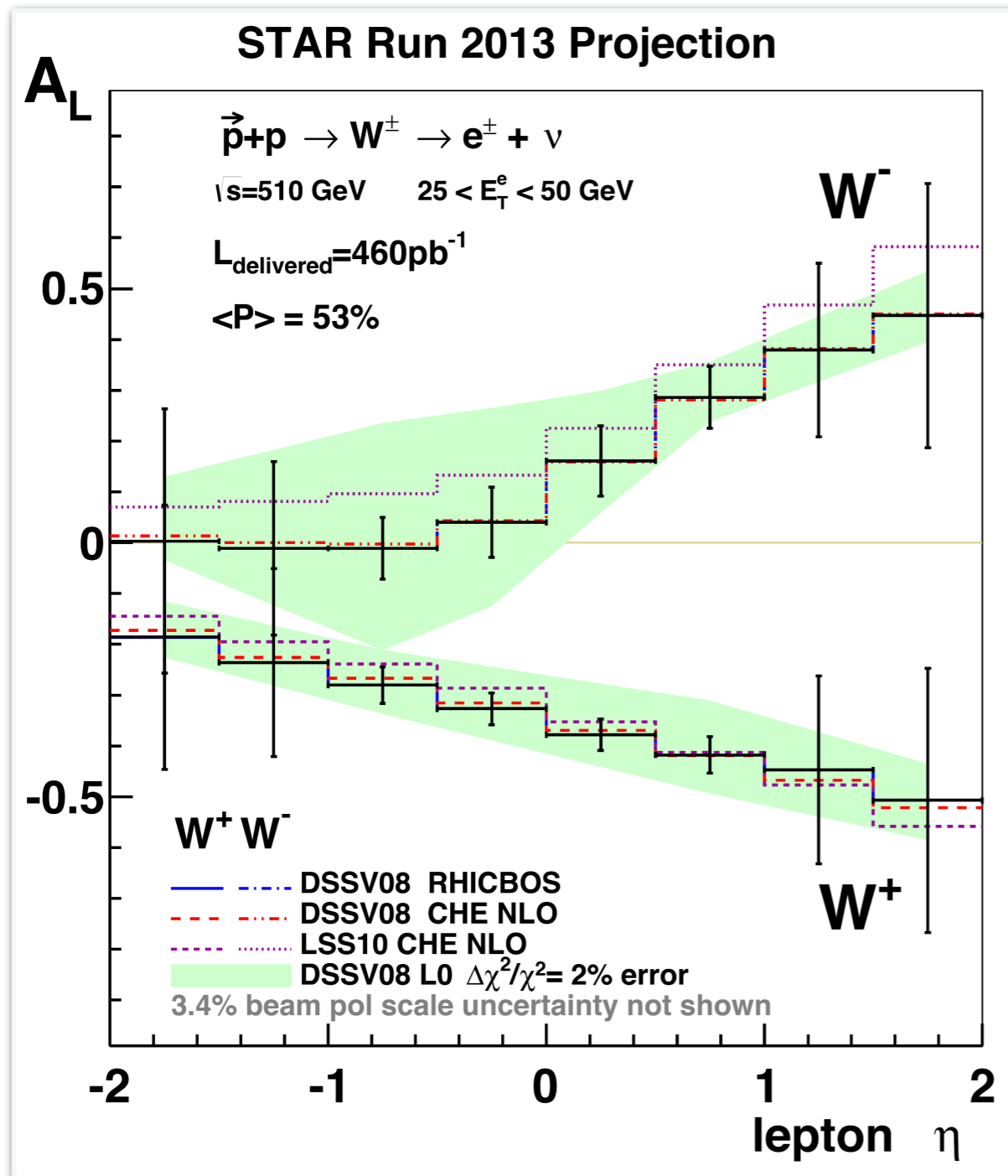

## Impact on antiquark polarization

### $\bar{u}$ polarization

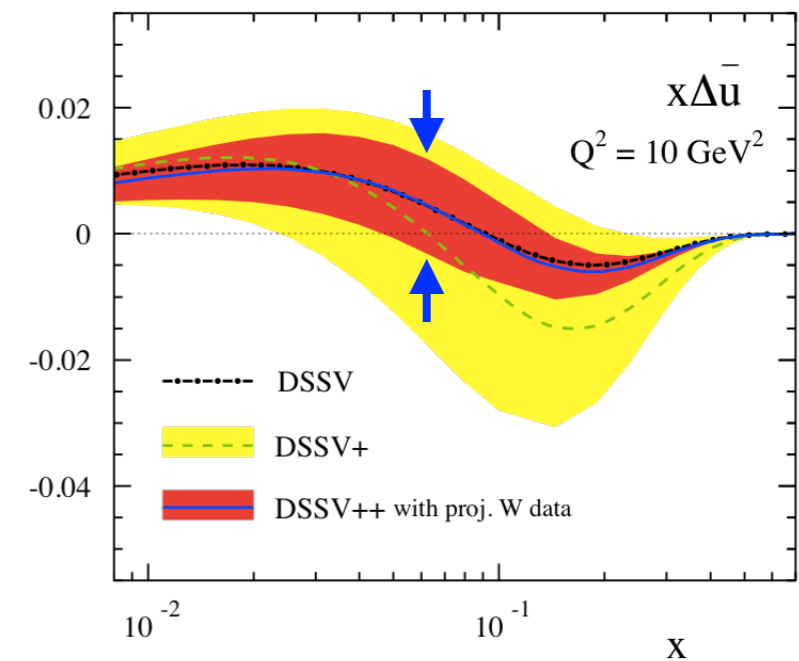

### $\bar{d}$ polarization

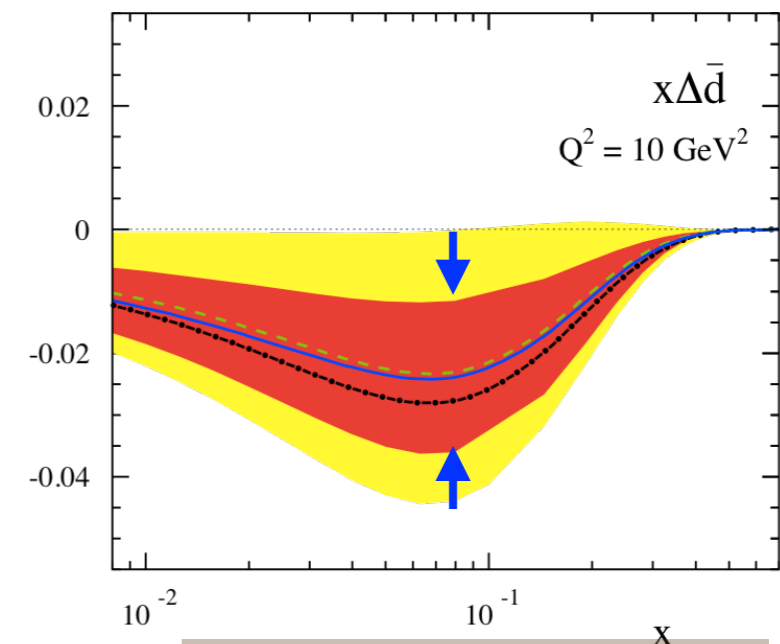

arXiv: 1304.0079

# Summary / Outlook

- ◆ **The Production of W Bosons in polarized p+p collisions provides a new means to study the spin and flavor asymmetries of the proton sea quark distributions**
- ◆ **STAR has measured the parity violating single-spin asymmetry  $A_L$  for  $|\eta_e| < 1.4$  from 2012 and 2011 data, providing the first detailed look at the asymmetry's  $\eta_e$  dependence.**
- ◆ **STAR 2012 W  $A_L$  results provide significant constraints on anti u and anti d quark polarization.**
- ◆ **The first half of the data from the high statistics 2013 run is in the final state of analysis and the analysis of the second half is under way.**
- ◆ **Projected results from 2013 data shows reduction of uncertainty compare to STAR previous results.**

# Backup



# Extracting Asymmetries using Profile Likelihood Method

- Profile Likelihood method used in extracting Asymmetries from combination of run 2012 and run 2011 data [simple gaussian uncertainties breakdown particularly for small 2011 data sample ]
- Define likelihood function for 8 spin-dependent yields from pair of symmetric  $\eta$  region of STAR

$$L = \prod_i^4 p(M_i^a | \mu_i^a) p(M_i^b | \mu_i^b) g(\beta^a) g(\beta^b)$$

$p(M_i | \mu_i)$  - Poisson probability, for measured spin sorted yield  $M_i$  in the expected value  $\mu_i$  given by:

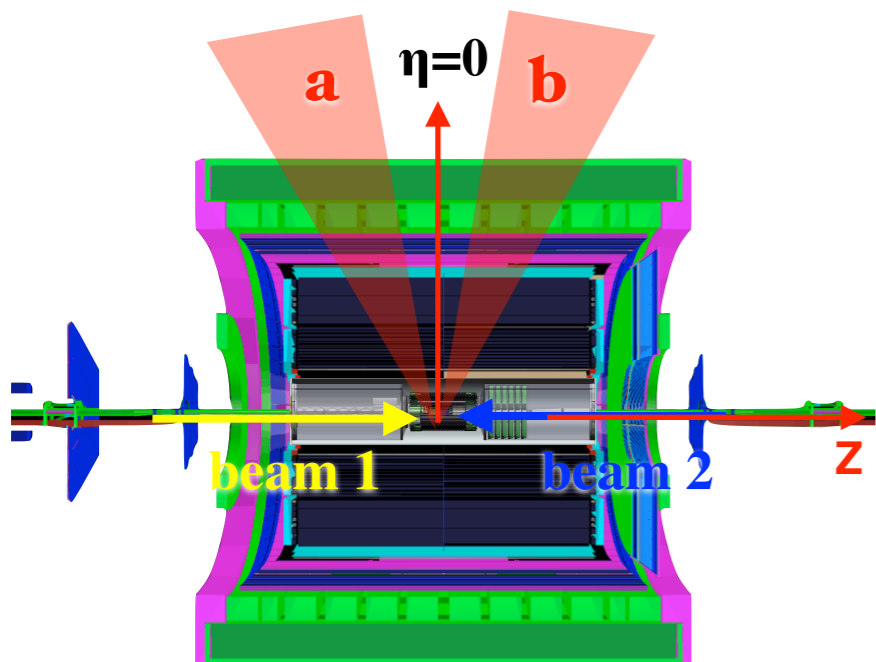

$$\mu_{++}^a = I_{++} N(1 + P_1 \beta A_L^{+\eta_e} + P_2 \beta A_L^{-\eta_e} + P_1 P_2 \beta A_{LL})$$

$$\mu_{+-}^a = I_{+-} N(1 + P_1 \beta A_L^{+\eta_e} - P_2 \beta A_L^{-\eta_e} - P_1 P_2 \beta A_{LL})$$

$$\mu_{-+}^a = I_{-+} N(1 - P_1 \beta A_L^{+\eta_e} + P_2 \beta A_L^{-\eta_e} - P_1 P_2 \beta A_{LL})$$

$$\mu_{--}^a = I_{--} N(1 - P_1 \beta A_L^{+\eta_e} - P_2 \beta A_L^{-\eta_e} + P_1 P_2 \beta A_{LL})$$

$P_1, P_2$  - beam polarization  $A_L^{+\eta_e} (A_L^{-\eta_e})$  - single spin asymmetry  
 $A_{LL}$  - double spin asymmetry  $N$  - spin averaged yield  $I_{\pm\pm}$  - relative luminosity

$g(\beta)$  - Gaussian probability for estimated dilution background  $\beta$

# STAR 2009 W Results

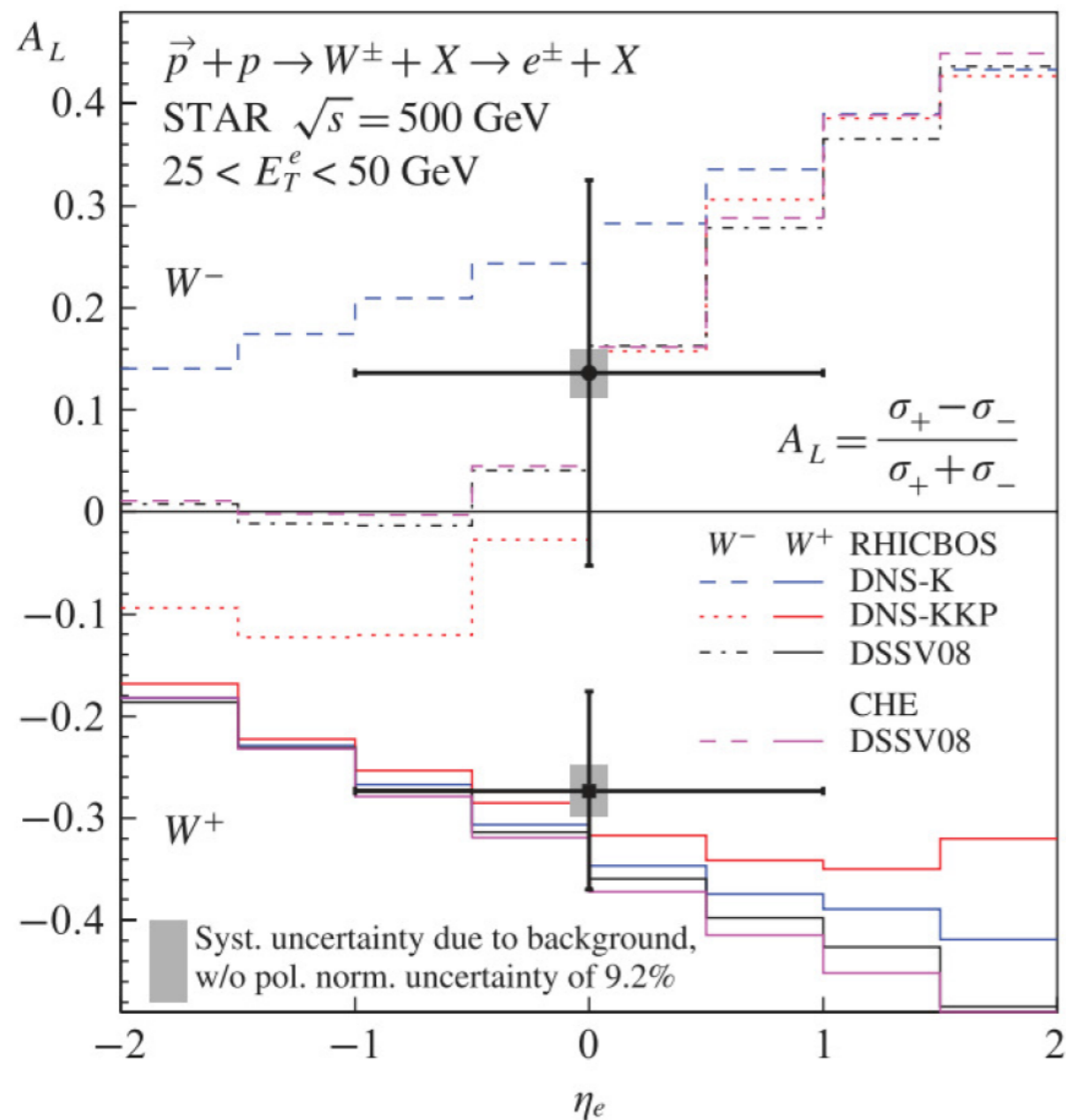

STAR pp500 Longitudinal		
Run	$L$ ( $pb^{-1}$ )	$W^+(W^-)$ raw yield
2009	12	462 (192)
2011	9	342 (103)
2012	77	2417 (734)

PRL 106, 062002 (2011)

# Mid-Rapidity charge sign separation

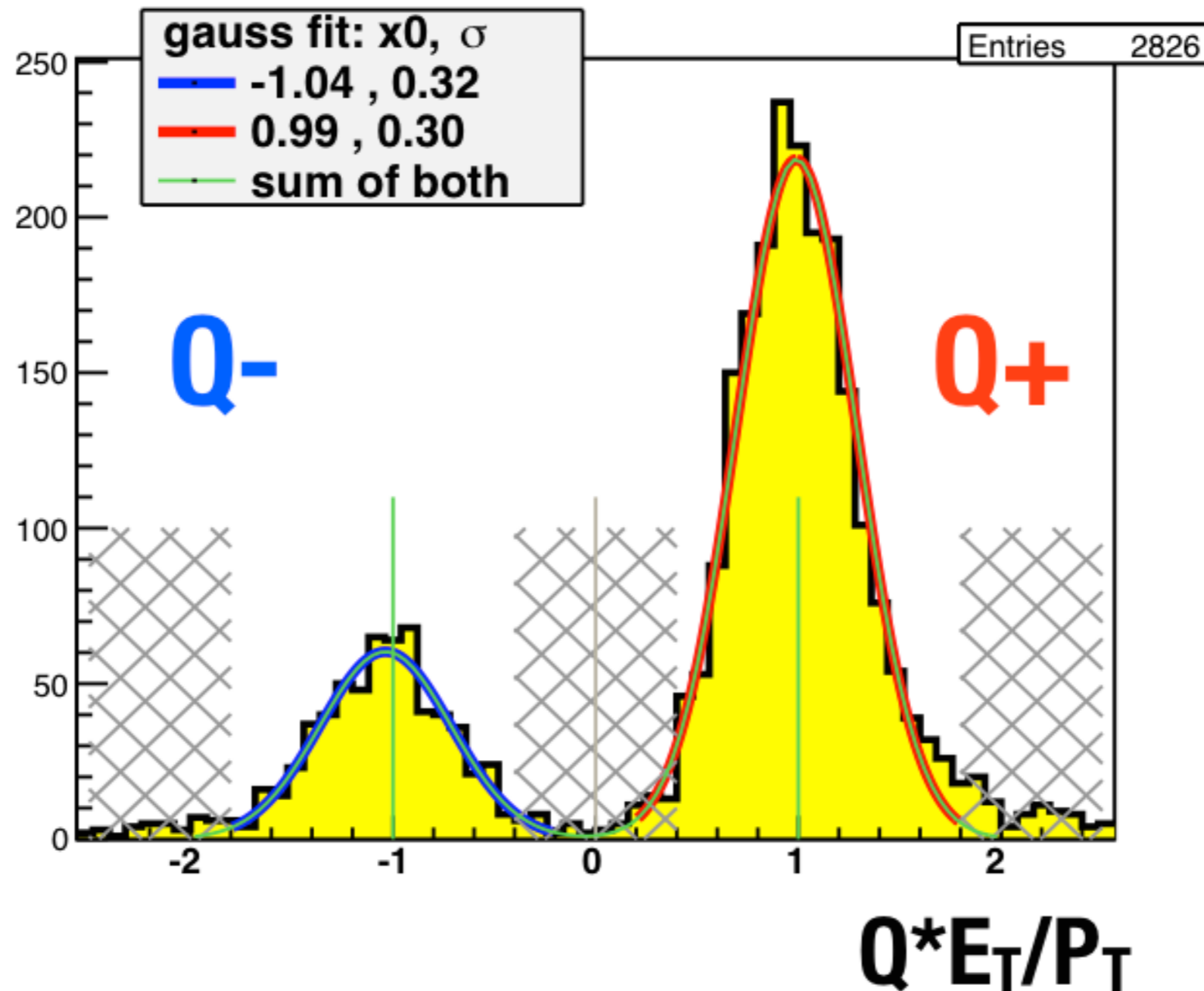

# Run 12 Preliminary results compare to Final

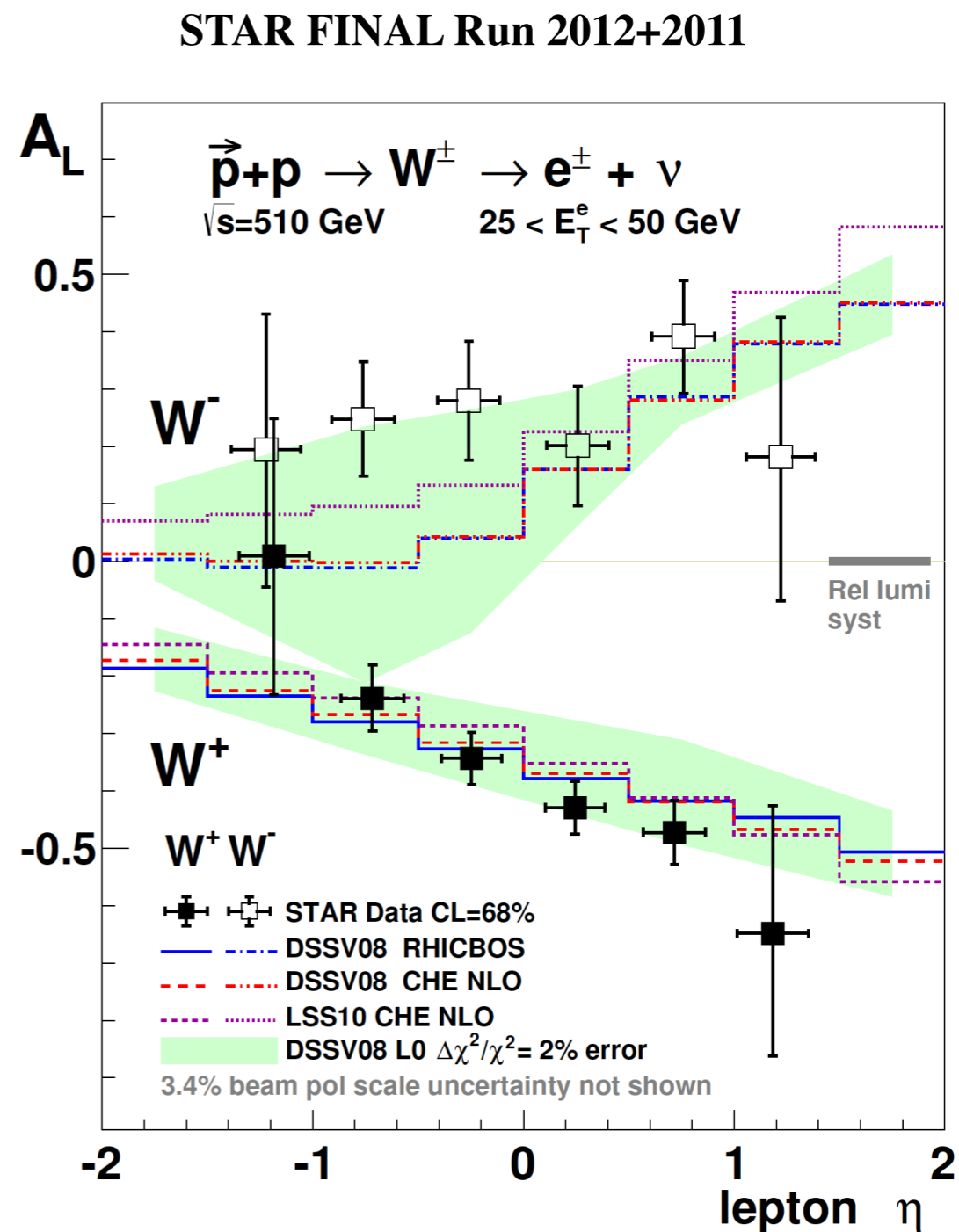
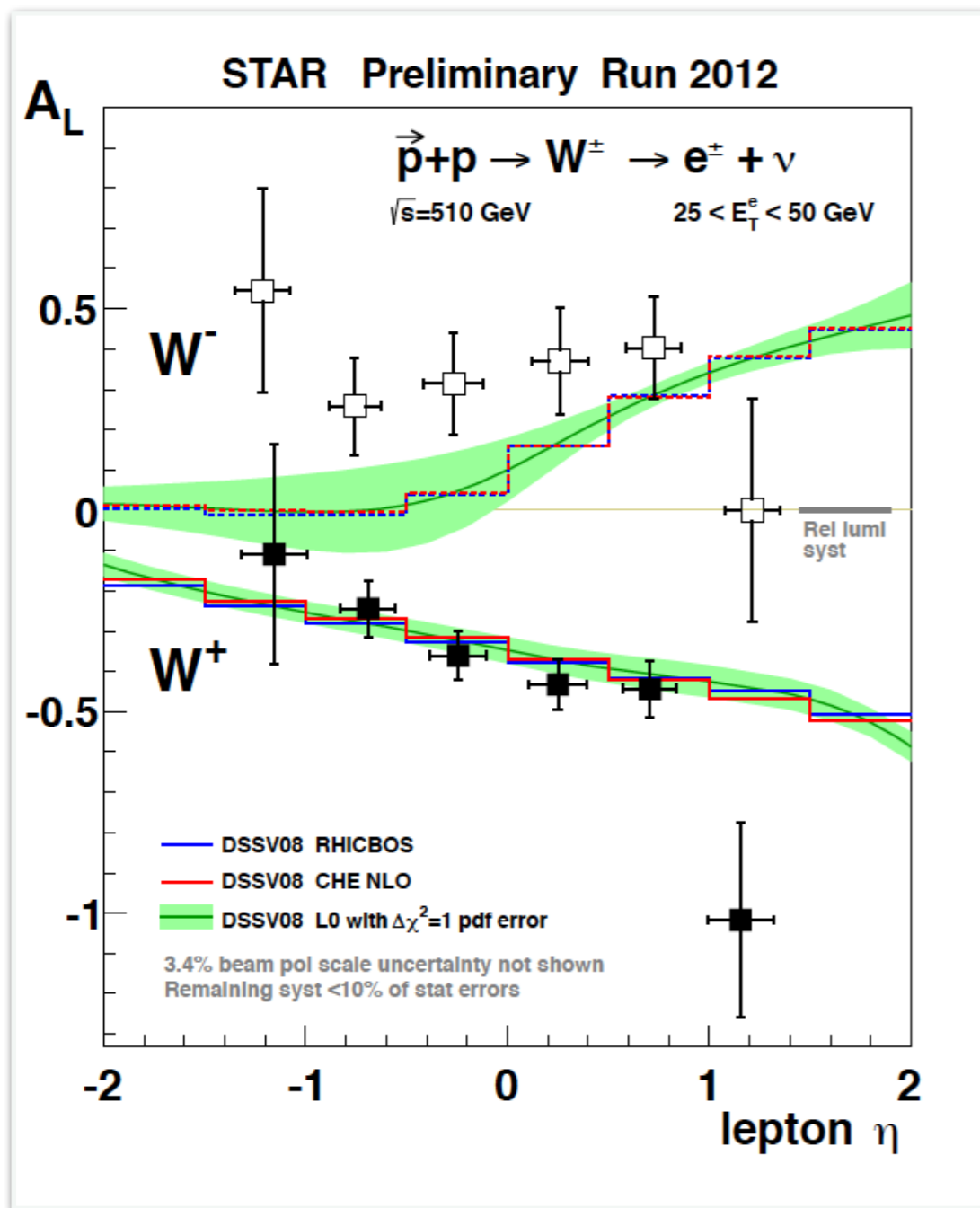

PRL 113,72301 (2014)

# Endcap W Selection

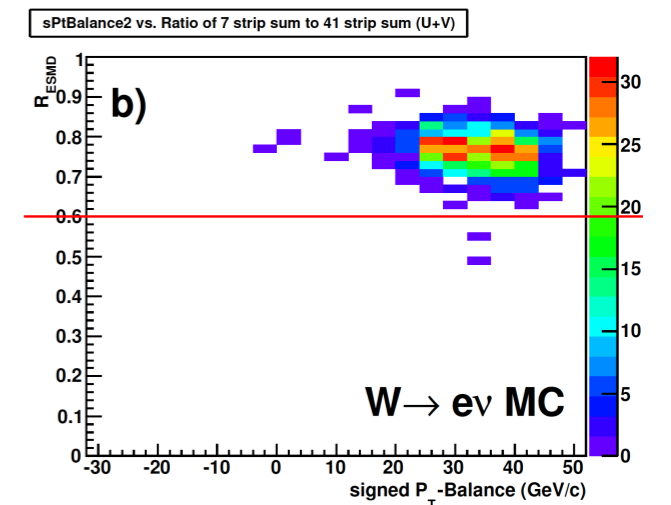
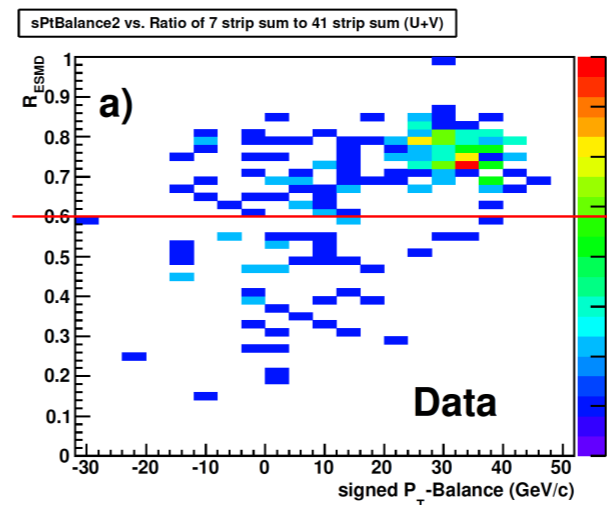
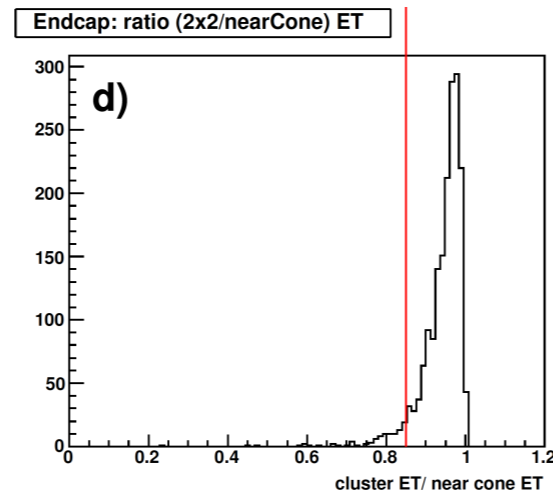
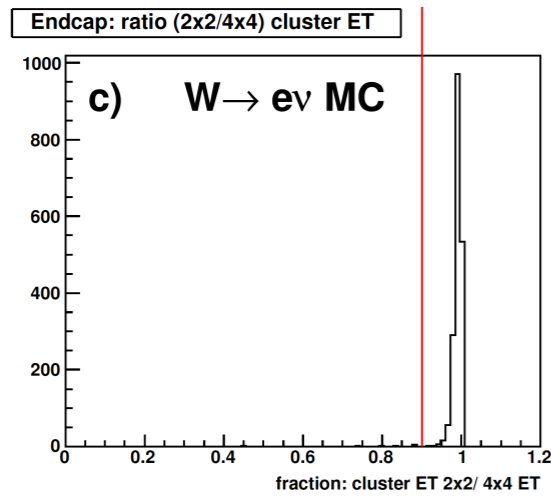
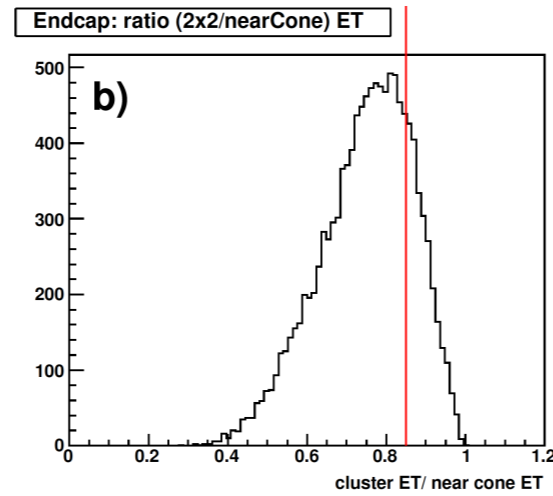
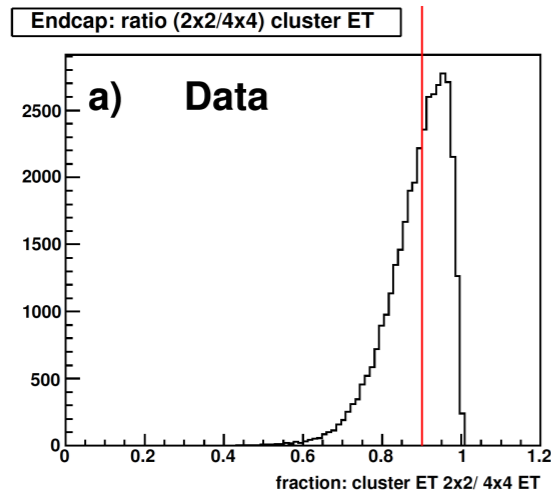

# ESMD CUTS

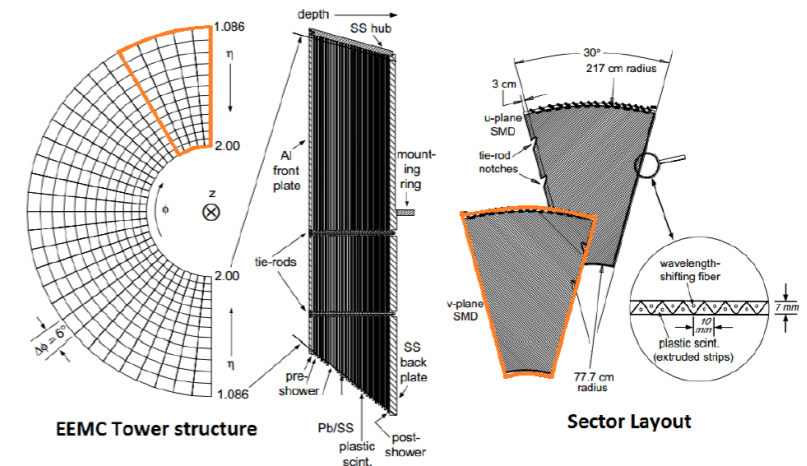
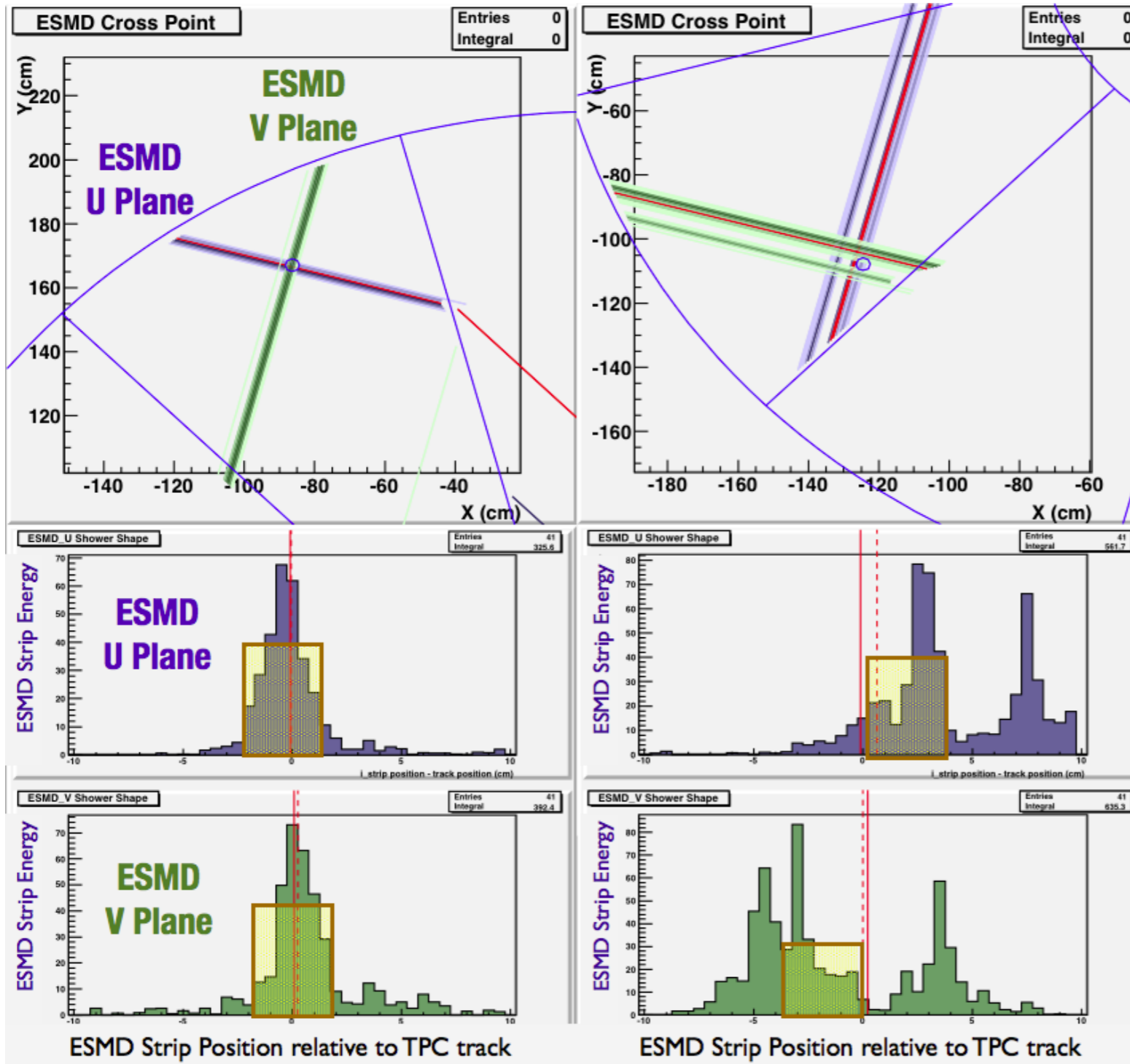

$$R_{ESMD} = \frac{\sum_{i=-3}^{+3} E_i^U + E_i^V}{\sum_{i=-20}^{+20} E_i^U + E_i^V}$$

# Forward Rapidity Background Estimation and charge sign separation

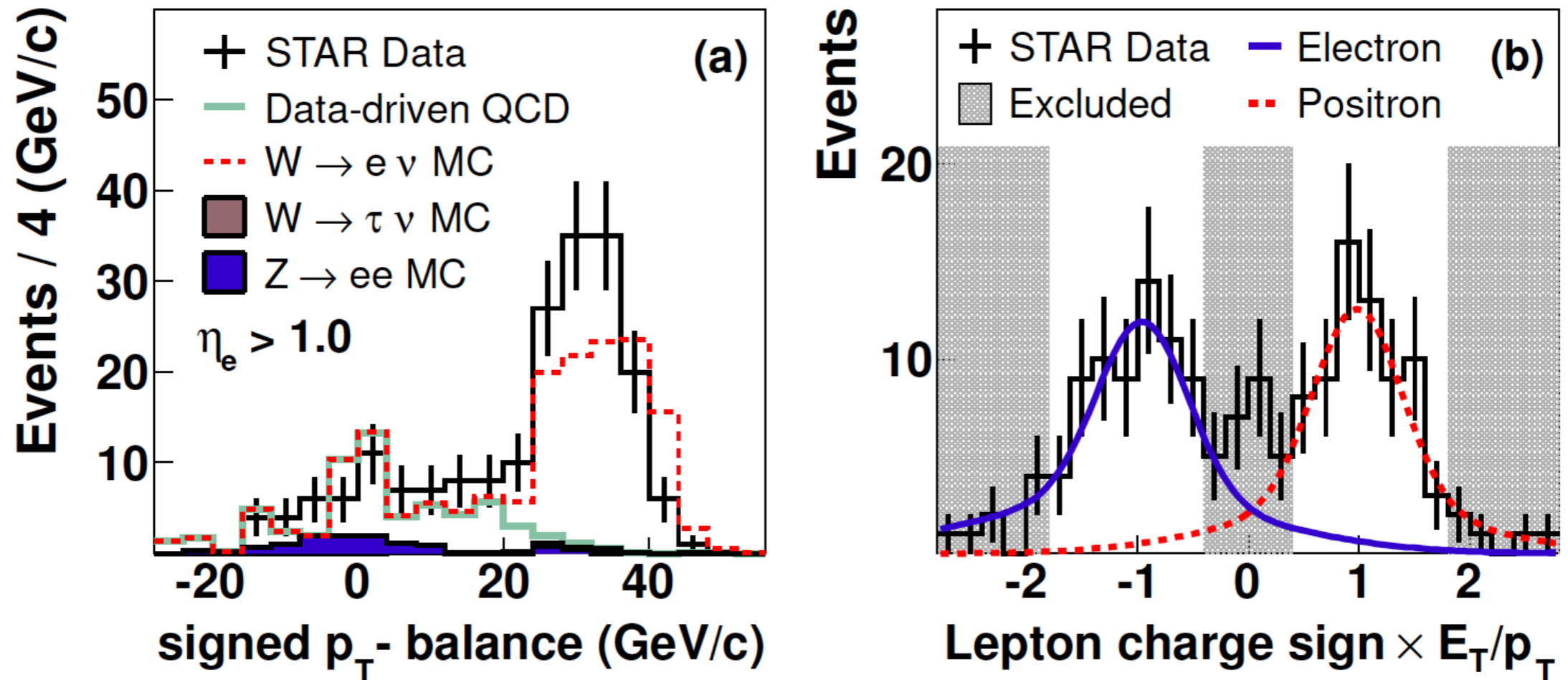

PRL 113,72301 (2014)

# Run 12 ALL and Z AL results

$$A_{LL} = \frac{(\sigma^{++} + \sigma^{--}) - (\sigma^{+-} + \sigma^{-+})}{(\sigma^{++} + \sigma^{--}) + (\sigma^{+-} + \sigma^{-+})}$$

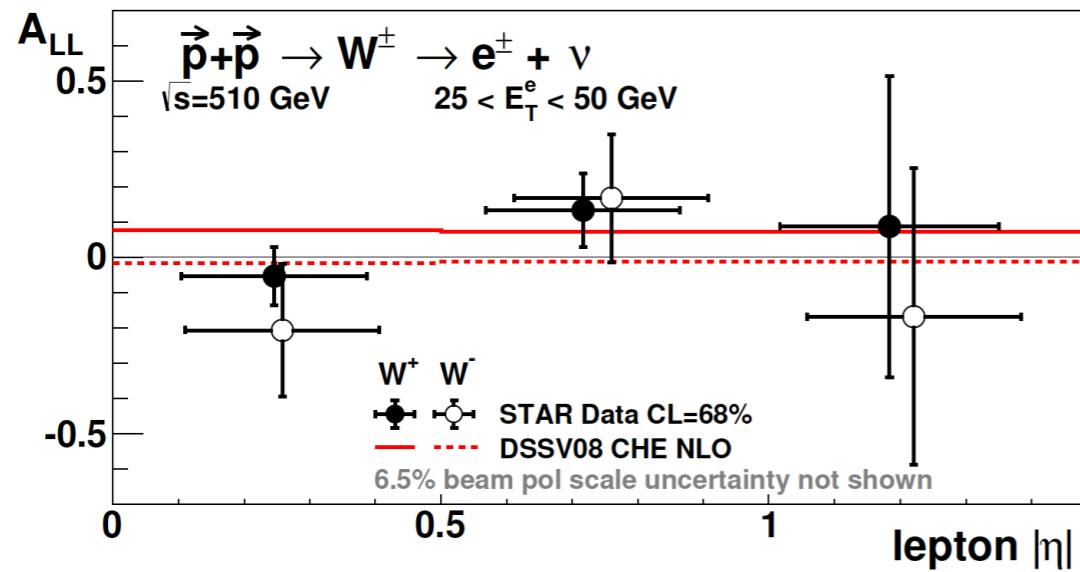

PRL 113,72301 (2014)

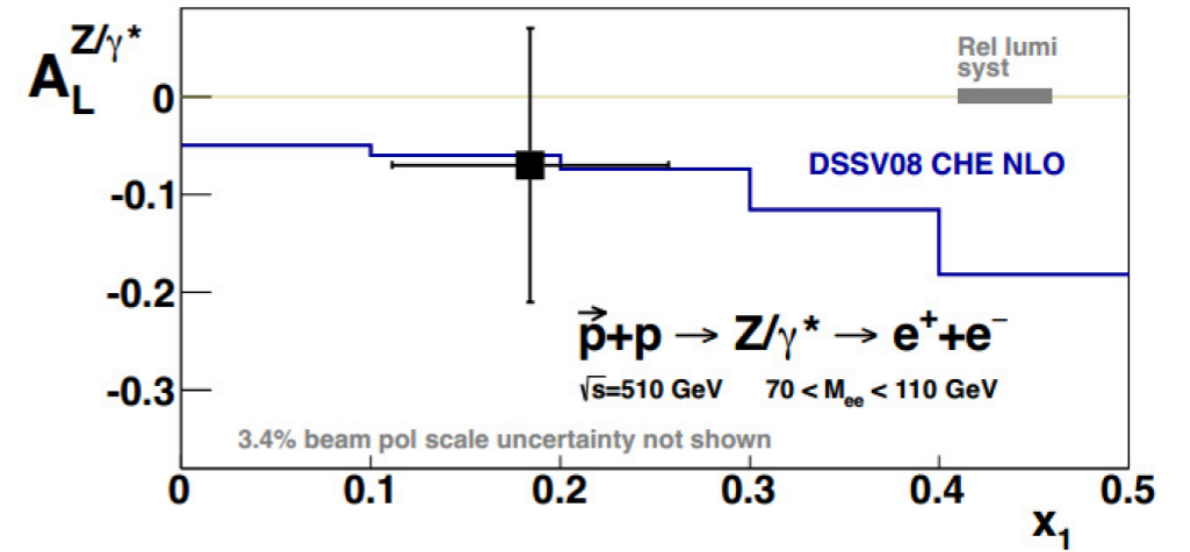

## Z invariant mass

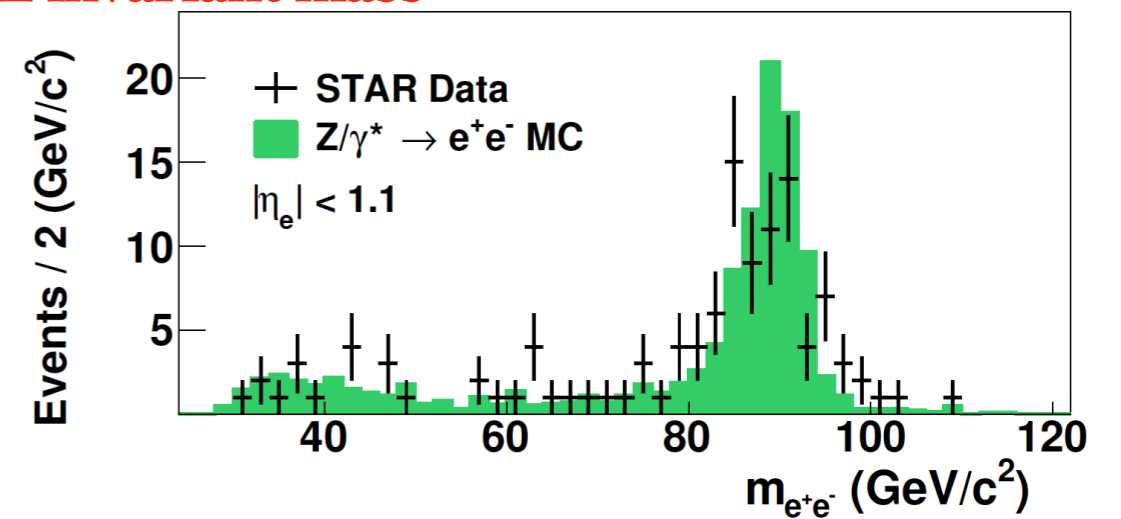

PRL 113,72301 (2014)



# W production: more details

Helicity structure can see in the differential cross section of W

$$\frac{d\sigma_{W^+}}{d\cos\theta} \propto \bar{d}(x_1)u(x_2)(1 + \cos\theta)^2 + u(x_1)\bar{d}(x_2)(1 - \cos\theta)^2$$

$$\frac{d\sigma_{W^-}}{d\cos\theta} \propto \bar{u}(x_1)d(x_2)(1 - \cos\theta)^2 + d(x_1)\bar{u}(x_2)(1 + \cos\theta)^2,$$

W tends to boost direction of the valance quark traveling

Helicity structure of the interaction causes lepton to emit parallel (antiparallel) to W-(W+)



higher (lower) x parton in the collision is most likely quark (antiquark) . And quark is very likely to come from valance region

W longitudinal momentum

e decay kinametics in lab frame related to W boost direction

$$p_{L,W} = \frac{\sqrt{s}}{2} (x_1 - x_2)$$

$$p_{L,e}^{lab} = \frac{1}{\gamma} p_{L,e}^* + \beta E_e^{lab}, \quad p_{L,e}^* = \cos\theta \cdot M_W/2 \quad (p_T^e = \sin\theta \cdot M_W/2),$$

# W, di-Jet and Z type events

simulated Z-ee event

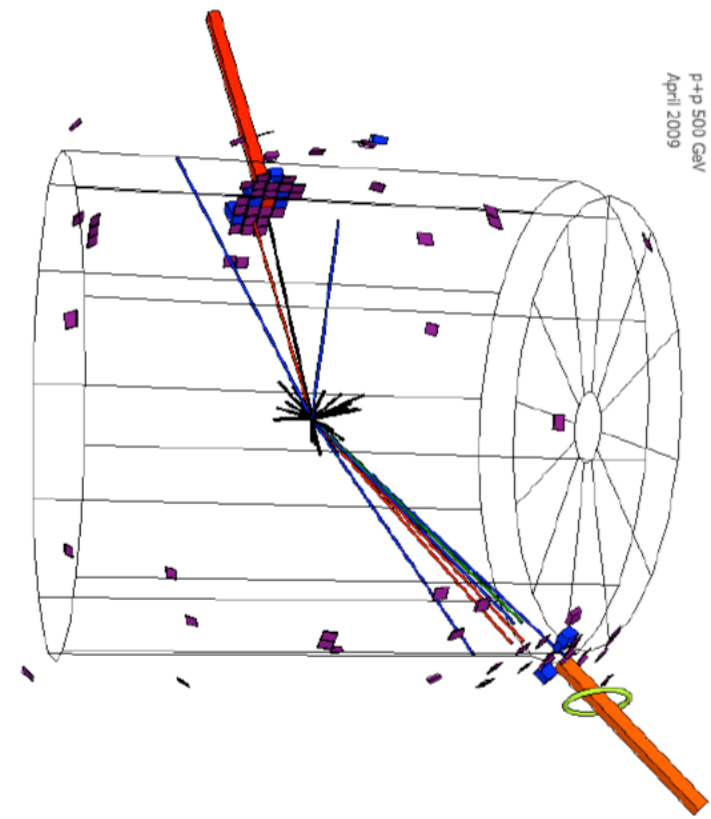
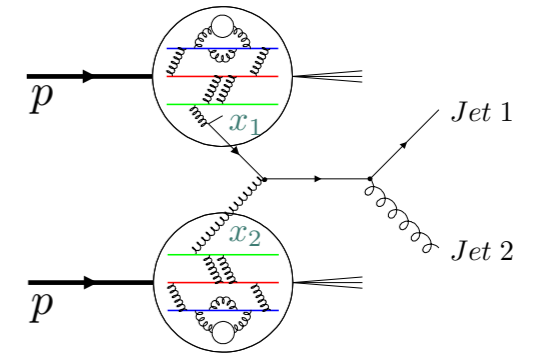
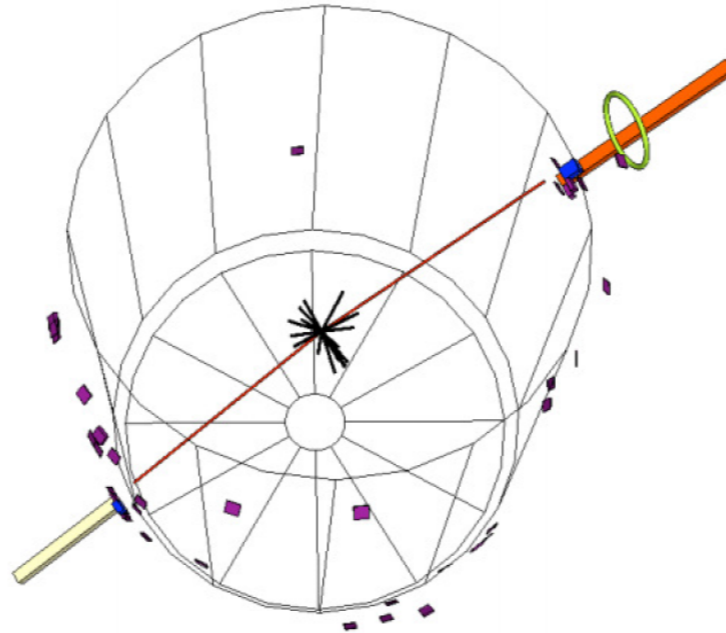
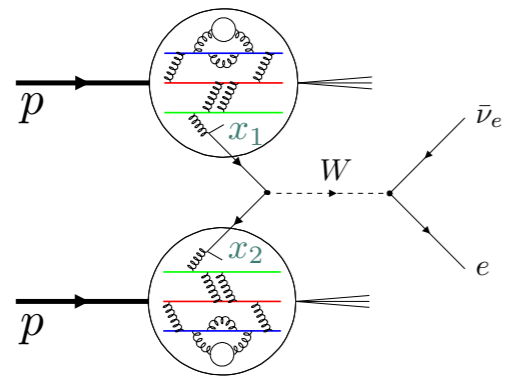

simulated di-jet event

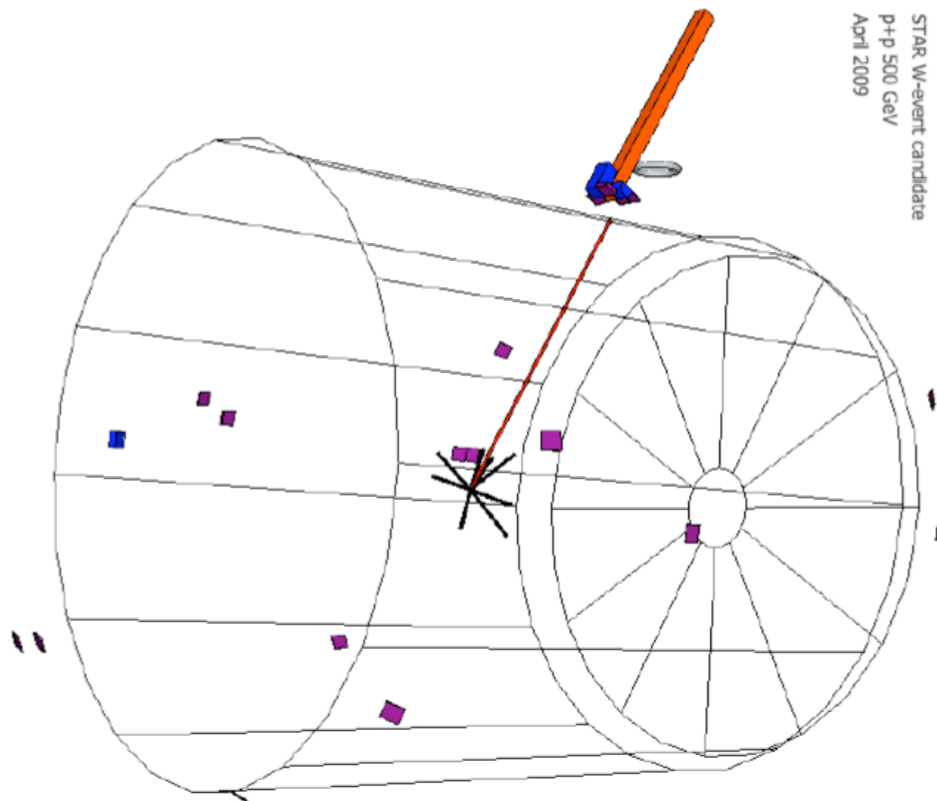

simulated W->e event

STAR W-event candidate  
p+p 500 GeV  
April 2009

STAR di-jet event  
p+p 500 GeV  
April 2009

# Mid-rapidity ( $|\eta_e| < 1$ ) $W$ Selection

❖ Match  $P_T > 10$  GeV TPC tracks to EMC cluster

$$E_T^e / E_T^{4 \times 4} > 0.95$$

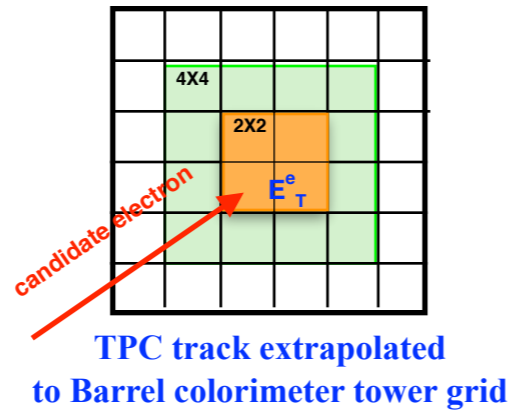

❖ Isolate from QCD di-jet type event

$$E_T^e / E_T^{\Delta R < 0.7} > 0.88$$

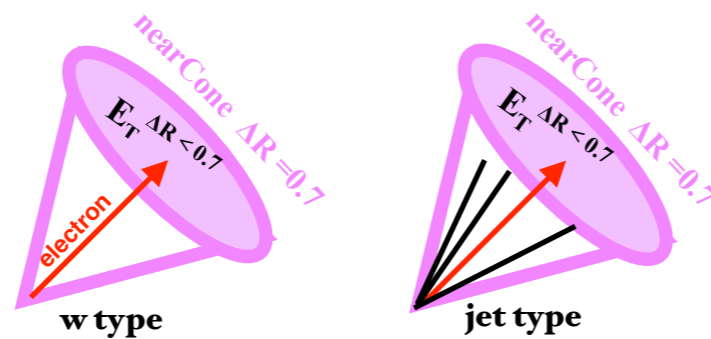

❖ Use Larger imbalance of transverse momentum

$$\vec{P}_T^{balance} = \vec{P}_T^e + \sum_{\Delta R > 0.7} \vec{P}_T^{jets}$$

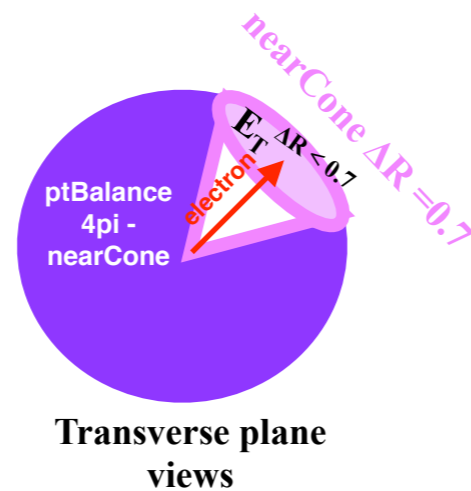

❖  $e^+$  and  $e^-$  Charge sign Separation

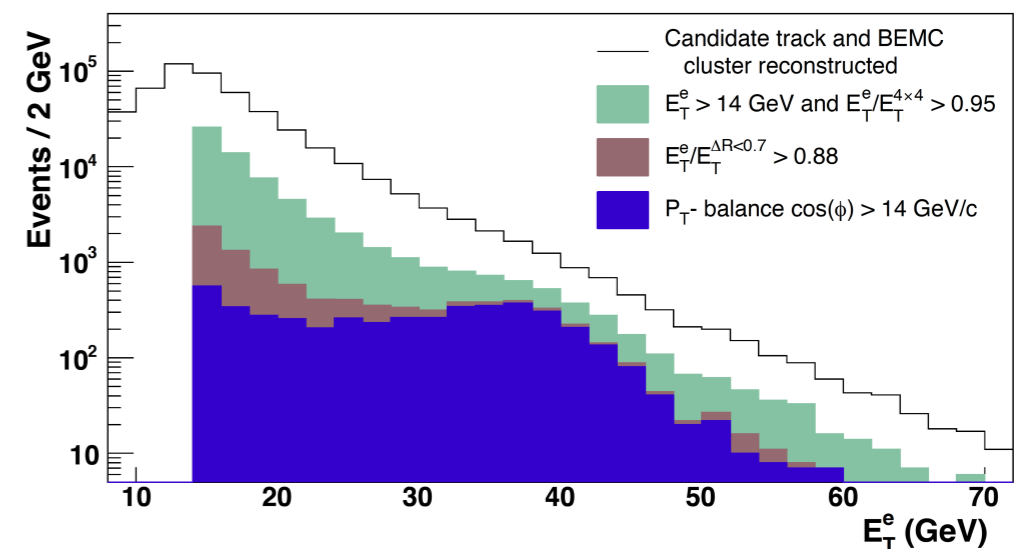
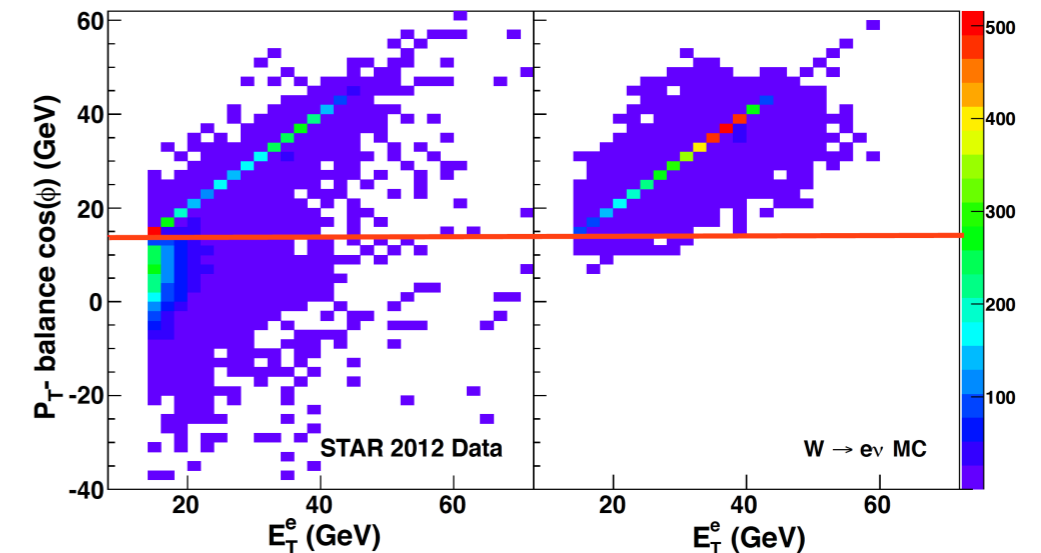
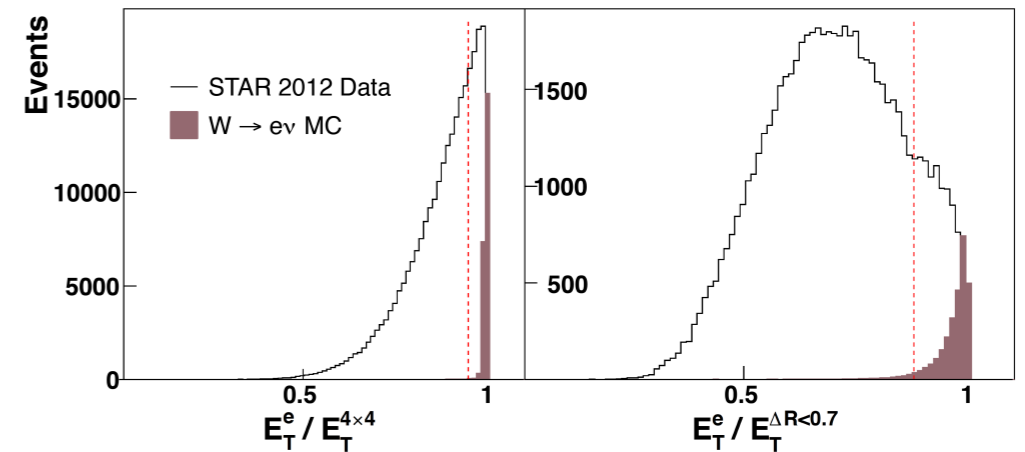

# FGT

## Illustration of charge-sign discrimination

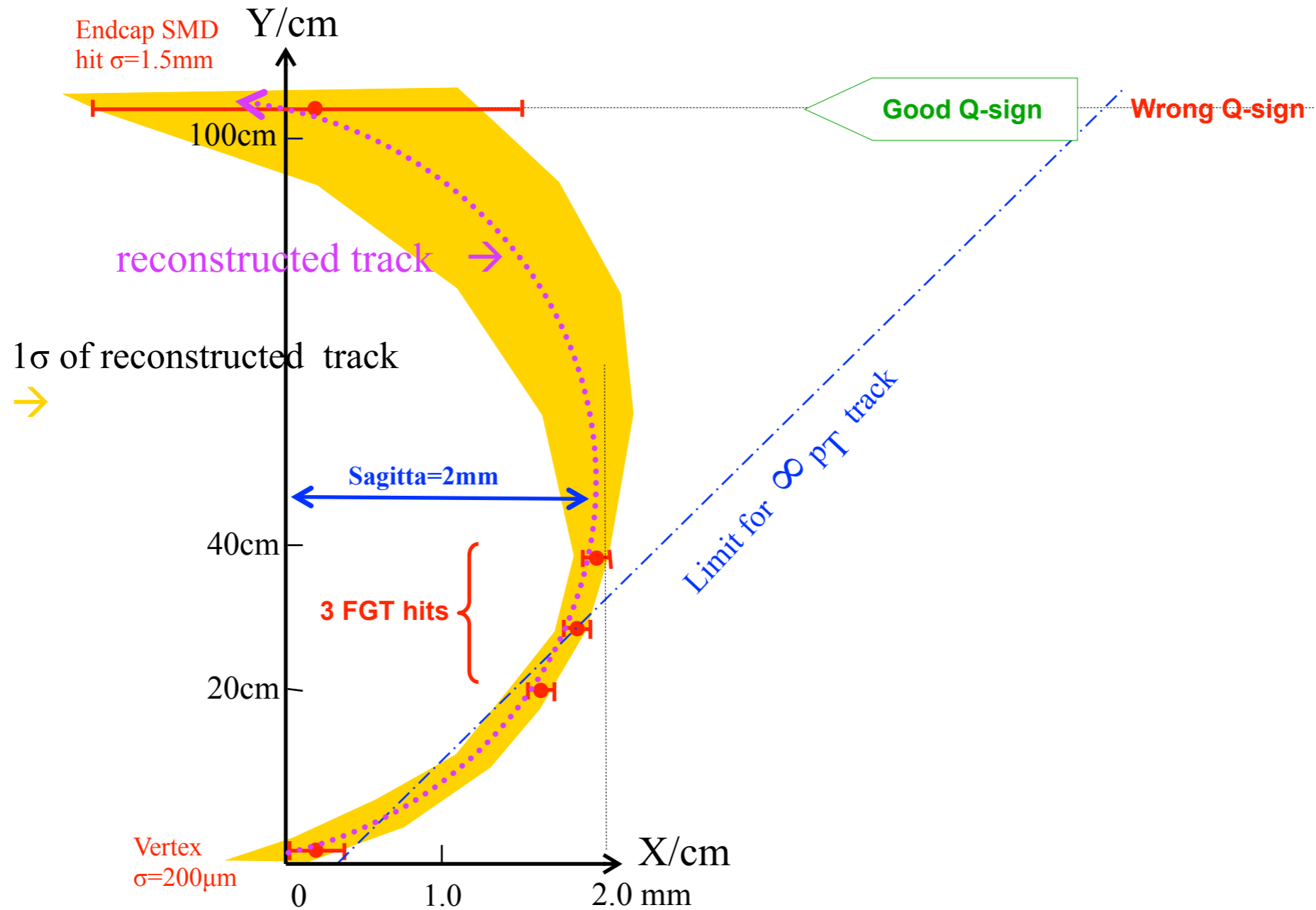

# FGT track reconstruction

- Comparison of data / fast MC: Track reconstruction

$R$  ISOLUTION

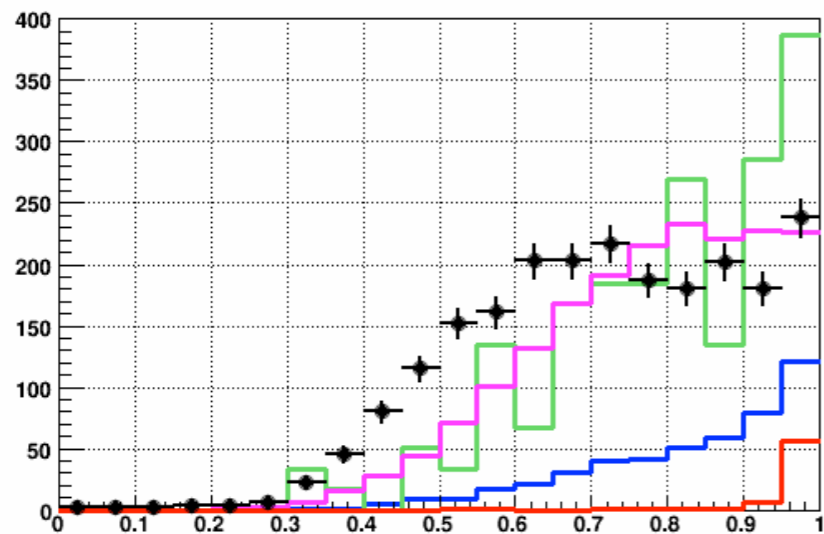

$p_T$  [GeV/c]

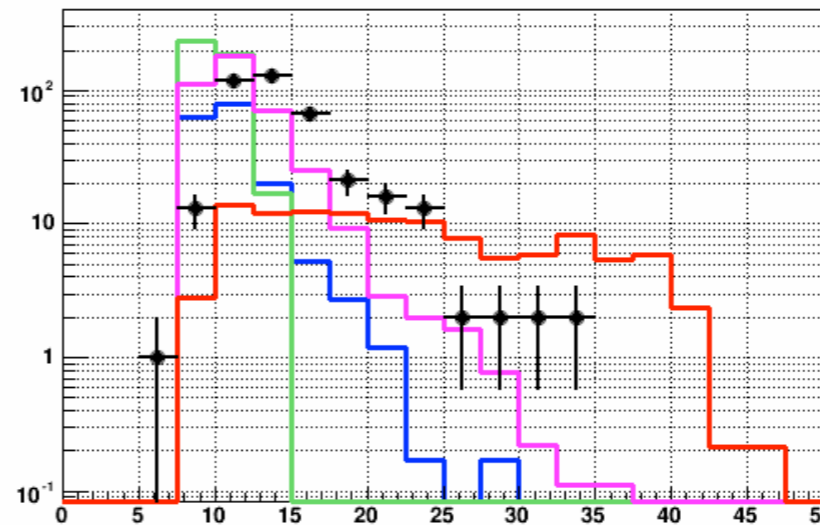

Run13 Data (FGT+VTX  
+EEMC, no prompt)

PYTHIA QCD charged  
hadrons

$E$  [GeV]

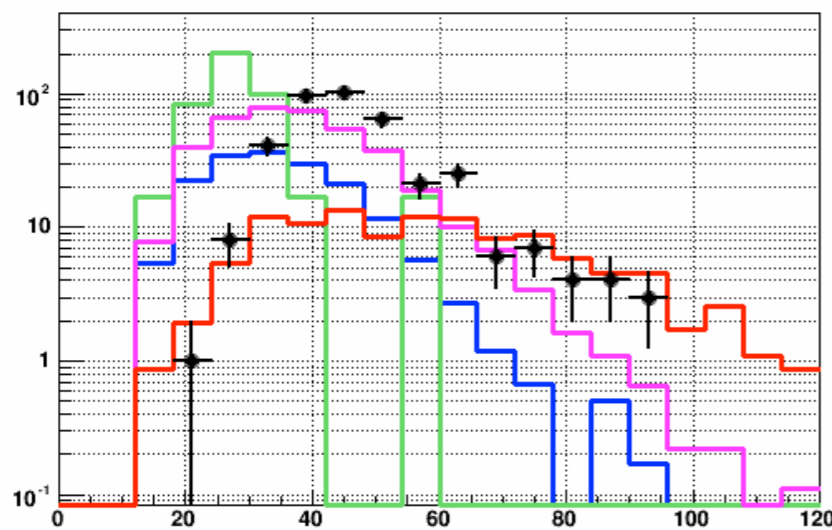

PseudoRapidity

50GeV/c

PYTHIA W

PYTHIA QCD electrons

PYTHIA QCD photons

100GeV

0

3

# Unpolarized BG $\beta$ and systematic uncertainties

● [simple gaussian uncertainties breakdown particularly for small 2011 data sample ]